

Design Marco Piva

ALINE
inox

Frattini
RUBINETTI DAL 1958

ALINE
inox

Design Marco Piva



Frattini
RUBINETTI DAL 1958

ALINE inox

Marco Piva sceglie l'acciaio inossidabile per la nuova collezione di rubinetterie disegnata per Fratelli Frattini: un oggetto innovativo, unico nel suo genere, sintesi tra funzione e forma.

Alto, robusto ed elegante, ha un corpo cilindrico slanciato che sorge da una sottile e leggera base quadrata. La sua maniglia, priva di tagli sul retro, è un prisma alternato di triangoli a tutta altezza ed esprime una geometria raffinata e rigorosa. La sua bocca filante è piatta e, grazie a particolari saldature all'avanguardia, è dotata di un erogatore dell'acqua ultrasottile con getto orientabile.

Lineare ed essenziale, il nuovo rubinetto è realizzato in acciaio inossidabile AISI 316L per essere resistente ad ogni tipo di aggressione esterna. Per questo motivo è adatto ad ogni spazio del benessere, da un lussuoso bagno privato ad un'esclusiva spa a cinque stelle oppure per la realizzazione dei bagni di un'imbarcazione prestigiosa.

È un prodotto ad alta tecnologia e di facile manutenzione: il connubio perfetto, tipico della migliore tradizione del Made in Italy, che si articola in una vasta gamma di prodotti pensati per affrontare la sfida della sostenibilità e ridurre i consumi d'acqua contribuendo alla tutela delle risorse idriche. **Un riduttore di flusso limita, infatti, l'erogazione a 6 litri al minuto.**

Aline Inox è per chi ama il design, la qualità e la longevità di un prodotto destinato a durare nel tempo.

Design: Marco Piva

Marco Piva chooses the stainless steel for the new collection of taps designed for Rubinetterie F.lli Frattini: an innovative object, one of a kind, a synthesis of function and form.

Tall, massive and elegant, whose cylindrical and slender body rises from a thin and light square base. Its handle, without cuts on the back, is an alternating prism of full-height triangles, to express a refined and rigorous geometry. Thanks to special state-of-the-art welding, the ultra slim spout is supplied with an ultra-thin saving water aerator with an adjustable jet.

Linear and essential, the new tap is made of stainless steel with a brushed stainless steel finishing and is resistant to all types of external aggression. For this reasons it is suitable for any wellness area: from a luxurious private bathroom to an exclusive five-star spa or for luxury bathrooms of a prestigious boat.

High-tech and easy maintenance product: the perfect matching typical of the Made in Italy tradition offered in a various and large product range designed to be sustainable and reduce water consumption by contributing to the protection of water resources. **A flow reducer limits to 6 Lt./minute the water flow.**

Aline inox is dedicated to the lovers of design, quality and long lasting products.





Litri al minuto
Liters per minute

49050

Monocomando per lavabo senza scarico.
Single-lever washbasin mixer without pop-up waste.







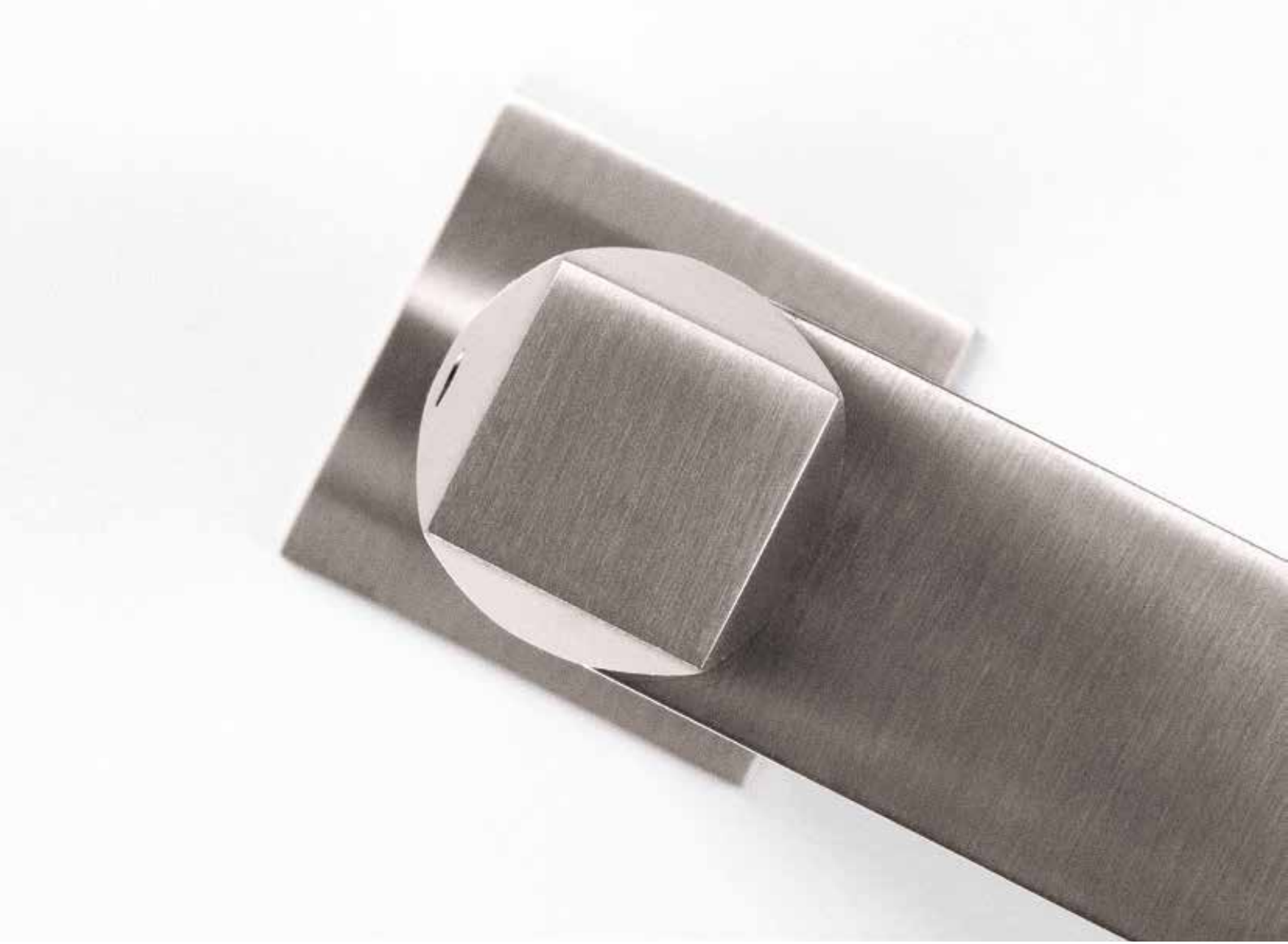

Frattini
RUBINETTI DAL 1958

ALINE
inox



Frattini
RUBINETTI DAL 1958





Litri al minuto
Liters per minute

49040
Monocomando lavabo modello medio senza scarico.
Medium version single-lever washbasin mixer without waste.







Litri al minuto
Liters per minute

49065
Monocomando lavabo modello alto senza scarico.
High version single-lever washbasin mixer without waste.







ALINE
inox



49068
Batteria lavabo con bocca alta fissa senza scarico.
3-hole washbasin mixer with fixed spout without pop-up waste.



ALINE
inox





ALINE
inox



Litri al minuto
Liters per minute

49548

Batteria lavabo a parete senza scarico.
Built-in washbasin mixer without pop-up waste.





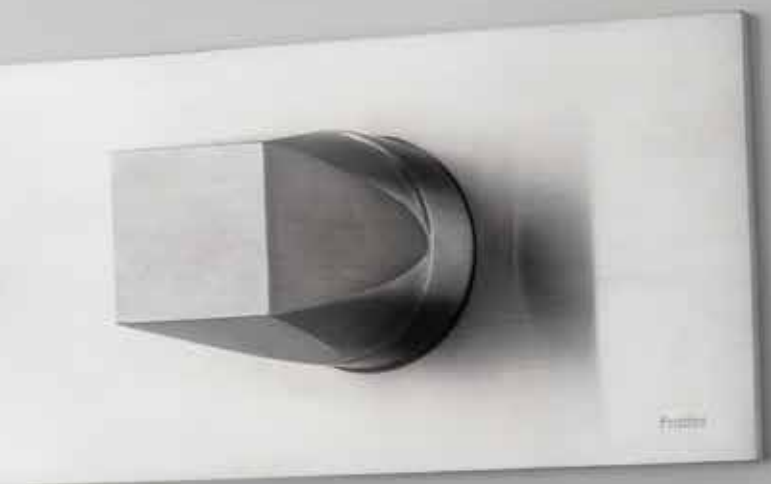



49528V2

monocomando vasca incasso con deviatore a dischi ceramici a 2 vie con bocca di erogazione.
External set for built-in bath mixer with 2-way ceramic discs diverter and spout.

89400

Supporto con presa acqua da incasso con flessibile in silicone bianco e doccia in acciaio.
Inlet water connection with bracket, white silicon flexible hose and stainless steel handshower.





ALINE
inox





49596
Monocomando vasca a pavimento con doccia.
Free standing bath mixer.

ALINE
inox





49600V3

Termostatico 3 vie pulsante.
3-way thermostatic built-in mixer with push button.





Frattini
RUBINETTI DAL 1958

49600V3

Termostatico 3 vie pulsante.
3-way thermostatic built-in mixer with push button.

49609

Soffione anticalcareo in acciaio inox 47x24 cm a doppia funzione pioggia e getto crystal.
47x24cm Stainless steel anticalcareous shower head with double function rain and laminar jet.

89400

Supporto con presa acqua da incasso con flessibile in silicone bianco e doccetta in acciaio.
Inlet water connection with bracket, white silicon flexible hose and stainless steel handshower.





49609

Soffione anticalcareo in acciaio inox 47x24 cm a doppia funzione pioggia e getto crystal.

47x24cm Stainless steel anticalcareous shower head with double function rain and laminar jet.

Frattini
RUBINETTI DAL 1958



TECHNICAL INFORMATION

ALINE
inox

.21 Inox 316L

49528V2 - 49528V3

Parte esterna visibile monocomando vasca incasso con deviatore a dischi ceramici a 2/3 vie con bocca di erogazione.

External set for built-in bath mixer with 2/3-way ceramic discs diverter and spout.

Kit de finition pour mitigeur de baignoire avec inverseur 2/3 voies à disques céramiques et bec.

Solo parte exterior monomando empotrado baño con inversor 2/3 vias discos ceramicos y caño.

Endmontage Sei für UP-

Wannenmischer mit 2/3-Wege Keramik Disk Umsteller und Auslauf.

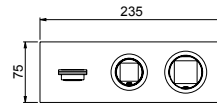
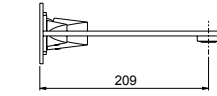

SYSTEM BOX

98028

Corpo per monocomando incasso doccia/vasca universale, cartuccia Ø35, 2/3 vie, con deviazione a dischi ceramici.

Universal built-in box bath/shower mixer, Ø35 cartridge, 2/3 way ceramic discs diverter.

Corps à encastrer universel mitigeur bain/douche, cartouche Ø35, inversion disques céramiques 2/3 voies.

Cuerpo empotrado universal para mezclador ducha/baño, cartucha Ø35, inversor discos ceramicos 2/3 vias.

UP-Universal Körper Wannen/Duschen Mischer, Ø35 Kartusche, 2/3 Wege Umsteller mit Keramik Scheiben.

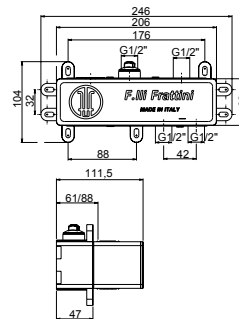

49596

Parte esterna visibile monocomando vasca a pavimento con doccia.

External visible components free standing bath mixer.

Kit de finition mitigeur de bain au sol avec douchette.

Sòlo parte exterior monomando baño de suelo con teleducha.

Endmontage Sei Standarmatur für Freistehende Badewanne.

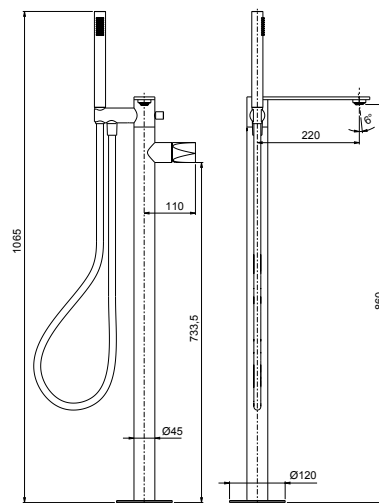

SYSTEM BOX

99095

Corpo per incasso vasca/lavabo universale a pavimento.

Universal built-in box free standing bath/basin mixer.

Corps à encastrer universel bain/lavabo sur pied.

Cuerpo empotrado universal para mezclador baño/lavabo de suelo.

UP-Universal Körper für freistehende Armaturen.

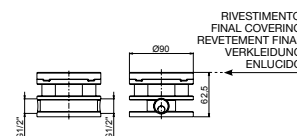



49028

Batteria per bordo vasca monocomando senza bocca con deviatore e doccia estraibile.
Deck mounted bath mixer with diverter and pull-out shower.
Mitigeur de bain sur gorge avec inverseur et douchette.
Monomando baño de repisa con inversor y teleducha.
Wannenrandmontage-Mischer mit Umsteller und Handbrause.

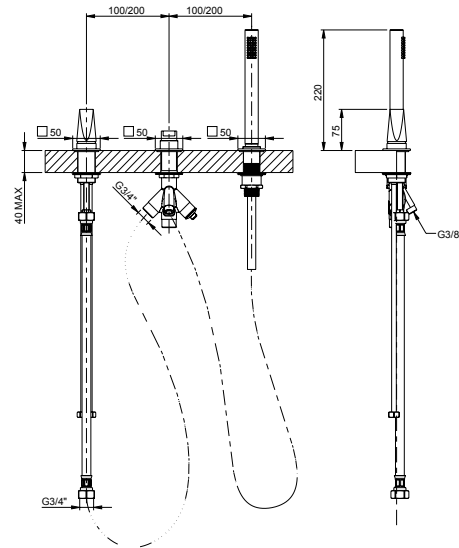

49029

Batteria per bordo vasca monocomando con bocca, deviatore e doccia estraibile.
Deck mounted bath mixer with diverter, pull-out shower and spout.
Mitigeur de bain sur gorge avec goulot, inverseur et douchette.
Monomando baño de repisa con caño, inversor y teleducha.
Wannenrandmontage-Mischer mit Auslauf, Umsteller und Handbrause.

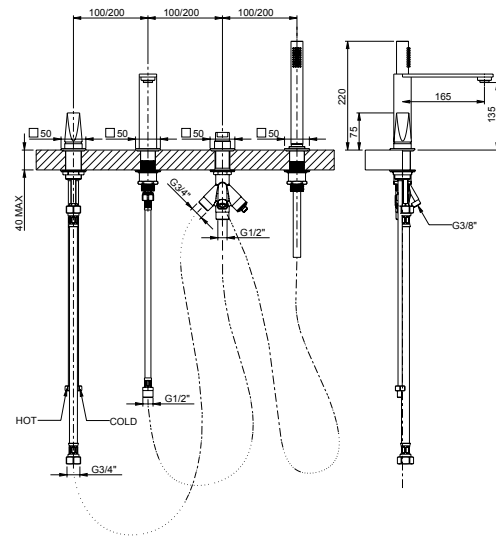

49548

Parte esterna visibile batteria lavabo a parete senza scarico.
External visible components built-in washbasin mixer without pop-up waste.
Kit de finition mitigeur de lavabo à encastrer sans vidage.
Sòlo parte exterior monomando lavabo empotrado sin descargo.
Endmontage Set Up-Waschtischmischer ohne Abfluss.

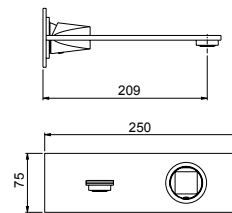

SYSTEM BOX

98038

Corpo per monocomando incasso lavabo universale, cartuccia Ø35.
Universal built-in box basin mixer, Ø35 cartridge.
Corps à encastrer universel mitigeur de lavabo, cartouche Ø 35.
Cuerpo empotrado universal para mezclador lavabo, cartucha Ø 35.
UP-Universal Körper für Waschtischmischer, Ø 35 Kartusche.

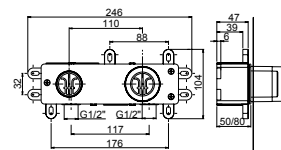



49050
Monocomando per
lavabo senza scarico.
Single-lever washbasin mixer
without pop-up waste.
Mitigeur de lavabo sans vidage.
Monomando lavabo sin descargo.
Waschtischmischer ohne Abfluss.

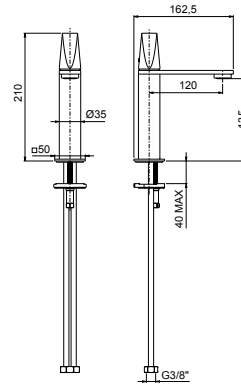

49040
Monocomando lavabo
modello medio senza scarico.
Medium version single-lever
washbasin mixer without waste.
Mitigeur de lavabo
medium sans vidage.
Monomando lavabo
medio sin descargo.
Mittelsständiger Waschtischmischer
ohne Abfluss.

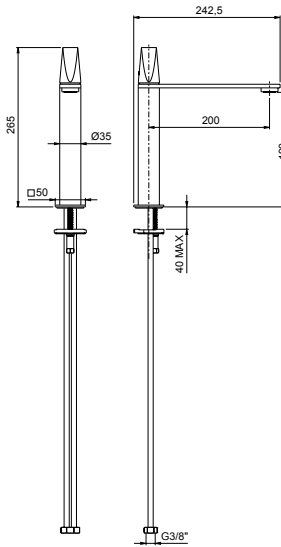

49065
Monocomando lavabo
modello alto senza scarico.
High version single-lever
washbasin mixer without waste.
Mitigeur de lavabo
haut sans vidage.
Monomando lavabo
alto sin descargo.
Hoher Waschtischmischer
ohne Abfluss.

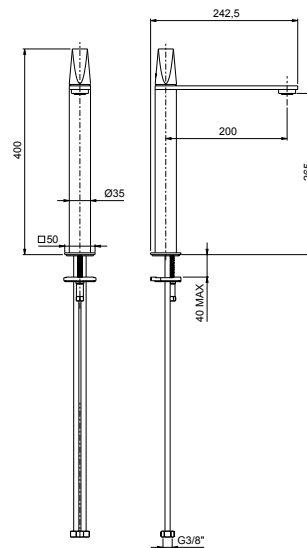



49595
 Parte esterna visibile monocomando
 lavabo senza scarico a pavimento.
 External visible components
 free standing basin mixer.
 Kit de finition mitigeur lavabo au sol.
 Sòlo parte exterior monomando
 lavabo de suelo.
 Endmontage Set Standarmatur
 für Freistehende Waschtisch.

SYSTEM BOX
 99095

Corpo per incasso vasca/lavabo
 universale a pavimento.
 Universal built-in box free
 standing bath/basin mixer.
 Corps à encastrer universel
 bain/lavabo sur pied.
 Cuerpo empotrado universal para
 mezclador baño/lavabo de suelo.
 UP-Universal Körper für freistehende
 Armaturen.

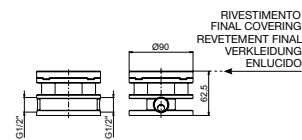
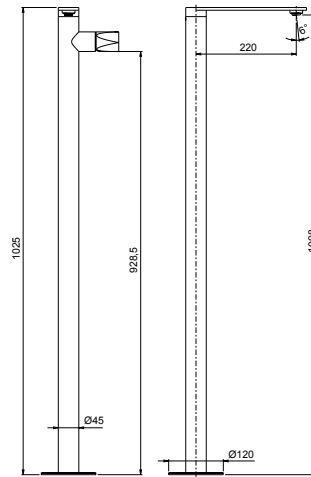

49058
 Lavabo con comando remoto.
 2 hole single lever washbasin mixer.
 Mitigeur monocommande
 de lavabo 2 trous.
 Mezclador monomando
 de lavabo a 2 vias.
 2-Loch Einhebel Waschtischmischer.

49032
 Solo comando remoto.
 Operating control only.
 Commande de fonctionnement.
 Mando a distancia.
 Betätigung Hebel.

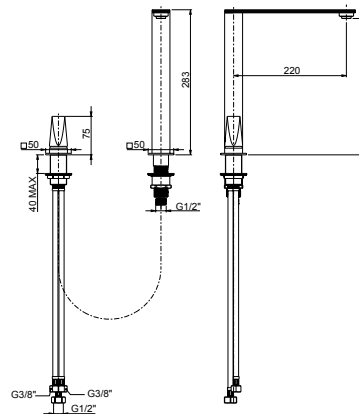

49889
 Solo bocca di erogazione.
 Spout only.
 Bec.
 Caño.
 Auslauf.



49103
 Monocomando per bidet
 con scarico 1"1/4.
 Single-lever bidet mixer
 with 1"1/4 pop-up waste.
 Mitigeur de bidet
 avec vidage 1"1/4.
 Monomando bidé
 con descargo 1"1/4.
 Bidetmischer mit 1"1/4 Abfluss.

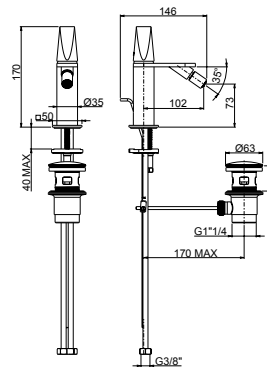

49080
 Monocomando per bidet
 senza scarico.
 Single-lever bidet mixer
 without pop-up waste.
 Mitigeur de bidet sans vidage.
 Monomando bidé sin descargo.
 Bidetmischer ohne Abfluss.

49068
 Batteria lavabo con bocca
 alta fissa senza scarico.
 3-hole washbasin mixer with fixed
 spout without pop-up waste.
 Mélangeur lavabo 3 trous
 avec bec fixe haut sans vidage.
 Batería lavabo con caño
 alto fijo sin descargo.
 3-Loch Waschtischbatterie mit hohem
 und festem Auslauf ohne Abfluss.

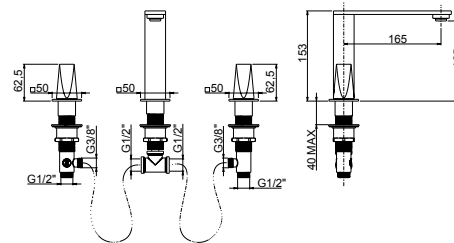

49104
 Batteria bidet con bocca
 alta fissa senza scarico.
 3-hole bidet mixer with fixed
 spout without pop-up waste.
 Mélangeur bidet 3 trous avec
 bec fixe haut sans vidage.
 Batería bidet con caño
 alto fijo sin descargo.
 3-Loch Bidet Batterie mit hohem
 und festem Auslauf ohne Abfluss.

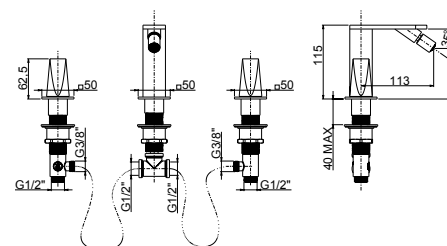

49527

Parte esterna visibile
monocomando incasso 1 via.
External part built-in
1 way single lever mixer.
Kit de finition monocommande
encastrée 1 voie.
Solo parte exterior
monomando empotrado 1 vía.
Endmontage Set UP-Einhebel
1 Weg Mischer.

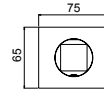

SYSTEM BOX
98916

Corpo per monocomando incasso
doccia universale, cartuccia
Ø35, 1 via.
Built-in single lever universal shower
mixer, Ø35 cartridge, 1 way.
Corps encastré pour
monocommande douche universel,
cartouche Ø 35, 1 voie.
Cuerpo empotrado universal
monomando ducha, cartucho
Ø35, 1 vía.
UP-Universal Einhebel Duschen
Mischer, Kartusche Ø35, 1 Weg.

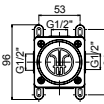
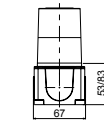

49521

Parte esterna visibile
monocomando incasso 1 via.
External visible components
1-way built-in mixer.
Kit de finition mitigeur
encastré 1 voie.
Solo parte exterior monomando
1 vía empotrado.
Endmontage Set UP-Mischer 1-Weg.

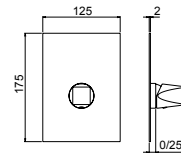

SYSTEM BOX
98011

Corpo per monocomando incasso
doccia universale, cartuccia Ø35,
1/2 vie, con deviazione a dischi
ceramici.
Universal built-in box shower mixer,
Ø35 cartridge, 1/2 way ceramic
discs diverter.
Corps à encastrer universel pour
mitigeur de douche, cartouche Ø35
inverseur disques céramiques 1-2 voies.
Cuerpo empotrado universal para
mezclador ducha, cartucha Ø35,
inversor discos ceramicos 1-2 vías.
UP-Universal Körper für Duschenmischer,
Ø35 Kartusche, 1-2 Wege Umsteller
mit Keramik Scheiben.

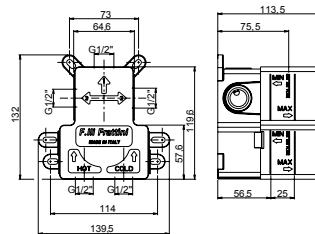

49541

Parte esterna visibile monocomando
 incasso con deviatore a
 dischi ceramici 2 vie.
 External visible components 2-way built-in
 mixer with ceramic discs diverter.
 Kit de finition mitigeur encastré 2 voies
 avec inverseur avec disques céramiques.
 Solo parte exterior monomando
 2 vias empotrado con inversor
 con discos ceramicos.
 Endmontage Set UP-Mischer 2-Wege
 mit Umsteller mit Keramik Scheiben.

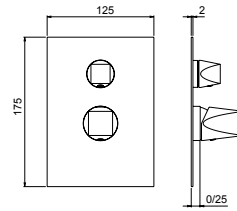

SYSTEM BOX
 98011

Corpo per monocomando incasso doccia
 universale, cartuccia Ø35, 1/2 vie, con
 deviazione a dischi ceramici.
 Universal built-in box shower mixer, Ø35
 cartridge, 1/2 way ceramic discs diverter.
 Corps à encaster universel pour mitigeur
 de douche, cartouche Ø35 inverseur
 disques céramiques 1-2 voies.
 Cuerpo empotrado universal para
 mezclador ducha, cartucha Ø35, inversor
 discos ceramicos 1-2 vias.
 UP-Universal Körper für Duschenmischer,
 Ø35 Kartusche, 1-2 Wege Umsteller mit
 Keramik Scheiben.

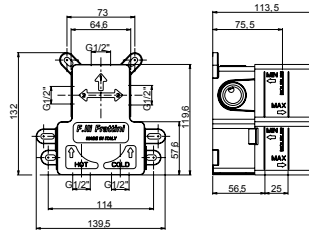

49529V2 - 49529V3

Parte esterna visibile monocomando
 incasso con deviatore a dischi ceramici
 2/3 vie con doccia fissa a riposo.
 External visible components 2-way
 built-in mixer with ceramic discs diverter
 with handshower.
 Kit de finition mitigeur encastré
 2/3 voies avec inverseur avec
 disques céramiques et douchette.
 Solo parte exterior monomando
 2/3 vias empotrado con inversor
 con discos ceramicos y teleducha.
 Endmontage Set UP-Mischer 2-/3Wege
 mit Umsteller mit Keramik Scheiben und
 Handbrause.

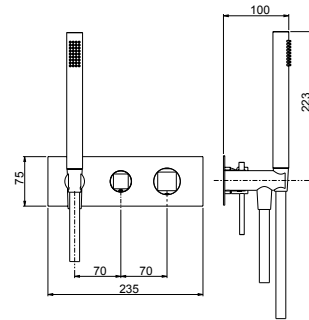

SYSTEM BOX
 98028

Corpo per monocomando incasso
 doccia/vasca universale, cartuccia Ø35,
 2/3 vie, con deviazione a dischi ceramici.
 Universal built-in box bath/shower mixer,
 Ø35 cartridge, 2/3 way ceramic
 discs diverter.
 Corps à encaster universel mitigeur
 bain/douche, cartouche Ø35,
 inversion disques céramiques 2/3 voies.
 Cuerpo empotrado universal para
 mezclador ducha/baño, cartucha Ø35,
 inversor discos ceramicos 2/3 vias
 UP-Universal Körper Wannen/Duschen
 Mischer, Ø35 Kartusche, 2/3 Wege
 Umsteller mit Keramik Scheiben.

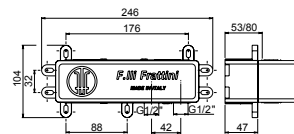

49523V2 - 49523V3

Parte esterna visibile monocomando
incasso con deviatore a dischi
ceramici 2-3 vie.

External visible components 2-3 way
built-in mixer with ceramic discs
diverter.
Kit de finition mitigeur encastré 2-3 voies
avec inverseur avec disques céramiques.
Solo parte exterior monomando
2-3 vias empotrado con inversor
con discos ceramicos.

Endmontage Set UP-Mischer 2-3 Wege
mit Umsteller mit Keramik Scheiben.

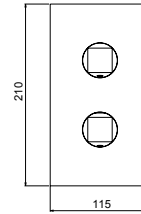

SYSTEM BOX

98013

Corpo per monocomando incasso doccia
universale, cartuccia Ø35, 2/3 vie,
con deviazione a dischi ceramici.

Universal built-in box shower mixer,
Ø35 cartridge, 2/3 way ceramic
discs diverter.

Corps à encastrer universel pour mitigeur
de douche, cartouche Ø35 inverseur
disques céramiques 2-3 voies.

Cuerpo empotrado universal para
mezclador ducha, cartucha Ø35,
inversor discos ceramicos 2-3 vias.

UP-Universal Körper für Duschenmischer,
Ø35 Kartusche, 2-3 Wege Umsteller
mit Keramik Scheiben

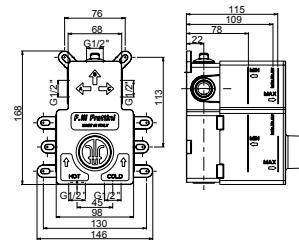

49712V2 - 49712V3

Parte esterna visibile miscelatore
incasso doccia termostatico con deviatore
a dischi ceramici 2-3 vie.

External visible components 2-3 way
built-in thermostatic shower mixer with
ceramic discs diverter.

Kit de finition mitigeur thermostatique à encastrer
2-3 voies avec inverseur avec disques céramiques.

Solo parte exterior monomando termostático
ducha empotrado 2-3 vias empotrado
con inversor con discos ceramicos.

Endmontage Set Up-Thermostat-Brausenmischer
2-3 Wege mit Umsteller mit Keramik Scheiben.

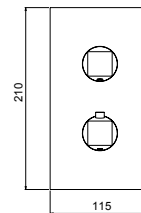

SYSTEM BOX

98712

Corpo per termostatico incasso doccia universale,
2/3 vie, con deviazione a dischi ceramici.

Universal thermostatic built-in shower mixer,
2/3 way ceramic discs diverter.

Corps à encastrer universel mitigeur
de douche thermostatique 2-3 voies.

Cuerpo empotrado universal para mezclador
termostatico ducha, inversor discos
ceramicos 2-3 vias.

UP-Universal Körper 2/3 Wege
Thermostat-Brausenmischer.

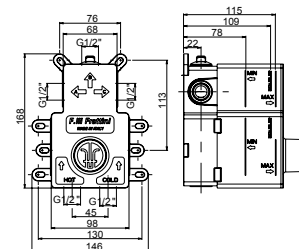



49760V2
 Parte esterna visibile incasso
 termostatico collettore 2 vie.
 External components 2-way
 thermostatic built-in shower manifold.
 Kit de finition collecteur douche
 thermostatique 2-voies encastré.
 Solo parte exterior distribuidor
 termostático ducha 2 vías empotrado.
 Endmontage UP- 2 Wege
 Thermostat Duschen Verteiler.

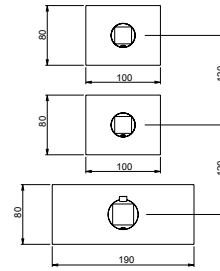

SYSTEM BOX
 98760V2

Corpo incasso termostatico
 collettore 2 vie universale.
 Built-in 2-way thermostatic
 shower manifold universal body.
 Corps universel encastré pour collecteur
 de douche 2 voies thermostatique.
 Cuerpo empotrado universal para
 distribuidor ducha 2 vías termostático.
 UP-Universal- Körper für 2 Wege
 Thermostat Duschen Verteiler.

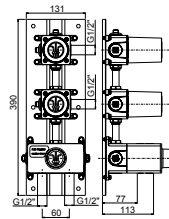

49760V3
 Parte esterna visibile incasso
 termostatico collettore 3 vie.
 External components 3-way
 thermostatic built-in shower manifold.
 Kit de finition collecteur douche
 thermostatique 3-voies encastré.
 Solo parte exterior distribuidor
 termostático ducha 3 vías empotrado.
 Endmontage UP- 3 Wege
 Thermostat Duschen Verteiler.

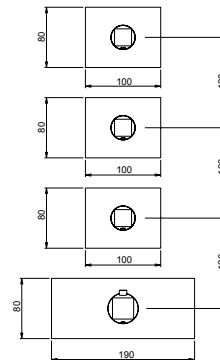

SYSTEM BOX
 98760V3

Corpo incasso termostatico
 collettore 3 vie universale.
 Built-in 3-way thermostatic
 shower manifold universal body.
 Corps universel encastré pour collecteur
 de douche 3 voies thermostatique.
 Cuerpo empotrado universal para
 distribuidor ducha 3 vías termostático.
 UP-Universal- Körper für 3 Wege
 Thermostat Duschen Verteiler.

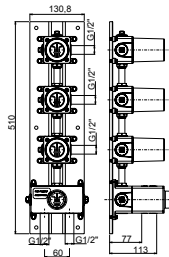



49760V4
 Parte esterna visibile incasso
 termostatico collettore 4 vie.
 External components 4-way
 thermostatic built-in shower manifold.
 Kit de finition collecteur douche
 thermostatique 4-voies encastré.
 Solo parte exterior distribuidor
 termostático ducha 4 vías empotrado.
 Endmontage UP- 4 Wege
 Thermostat Duschen Verteiler.

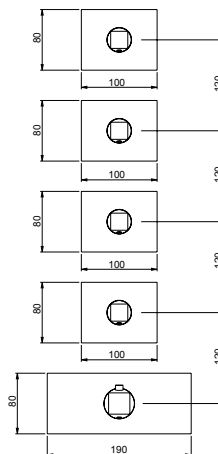

**SYSTEM BOX
 98760V4**
 Corpo incasso termostatico
 collettore 4 vie universale.
 Built-in 4-way thermostatic
 shower manifold universal body.
 Corps universel encastré pour collecteur
 de douche 4 voies thermostatique.
 Cuerpo empotrado universal para
 distribuidor ducha 4 vías termostático.
 UP-Universal- Körper für 4 Wege
 Thermostat Duschen Verteiler.

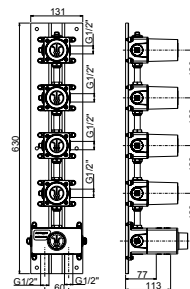

49760V5
 Parte esterna visibile incasso
 termostatico collettore 5 vie.
 External components 5-way
 thermostatic built-in shower manifold.
 Kit de finition collecteur douche
 thermostatique 5-voies encastré.
 Solo parte exterior distribuidor
 termostático ducha 5 vías empotrado.
 Endmontage UP- 5 Wege
 Thermostat Duschen Verteiler.

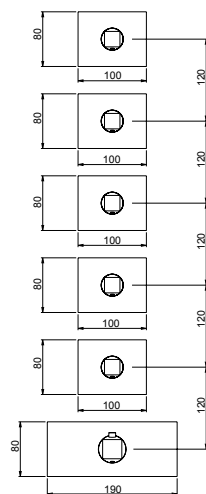

**SYSTEM BOX
 98760V5**
 Corpo incasso termostatico
 collettore 5 vie universale.
 Built-in 5-way thermostatic
 shower manifold universal body.
 Corps universel encastré pour collecteur
 de douche 5 voies thermostatique.
 Cuerpo empotrado universal para
 distribuidor ducha 5 vías termostático.
 UP-Universal- Körper für 5 Wege
 Thermostat Duschen Verteiler.

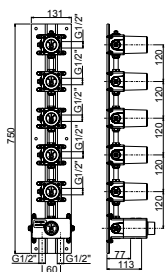

49600V2

Parte esterna visibile incasso termostatico
2 vie, pulsanti con regolazione di portata.
External visible components 2-way
thermostatic built-in mixer with push
button and flow adjustment.

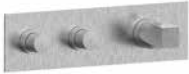

Kit de finition mitigeur 2-voies encastré
thermostatique à poussoir avec
réglage de débit.

Solo parte exterior mezclador termostático
empotrado 2 vías con botón pulsador y
regulación de caudal.

Endmontage Set UP 2 Wege
Thermostat Mischer mit Druckknopf und
Wasserdurchfluss Adjustierung.

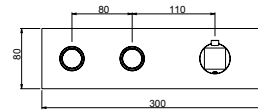

SYSTEM BOX

98600V2

Corpo incasso termostatico 2 vie,
pulsanti con regolazione di portata.
Built-in 2-way push button thermostatic
mixer body with flow adjustment.



Corp encastré 2-voies thermostatique
à poussoir avec réglage de débit.
Cuerpo empotrado 2 vías termostático
con botón pulsador y regulación
de caudal.

UP- Druckknopf 2 Wege Thermostat Körper
mit Wasserdurchfluss Adjustierung.

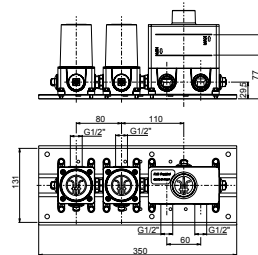

49600V3

Parte esterna visibile incasso termostatico
3 vie, pulsanti con regolazione di portata.
External visible components 3-way
thermostatic built-in mixer with push
button and flow adjustment.

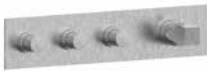

Kit de finition mitigeur 3-voies encastré
thermostatique à poussoir avec
réglage de débit.

Solo parte exterior mezclador termostático
empotrado 3 vías con botón pulsador y
regulación de caudal.

Endmontage Set UP 3 Wege
Thermostat Mischer mit Druckknopf und
Wasserdurchfluss Adjustierung.

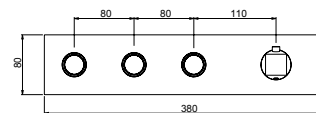

SYSTEM BOX

98600V3

Corpo incasso termostatico 3 vie,
pulsanti con regolazione di portata.
Built-in 3-way push button thermostatic
mixer body with flow adjustment.



Corp encastré 3-voies thermostatique
à poussoir avec réglage de débit.
Cuerpo empotrado 3 vías termostático
con botón pulsador y regulación
de caudal.

UP- Druckknopf 3 Wege Thermostat Körper
mit Wasserdurchfluss Adjustierung.

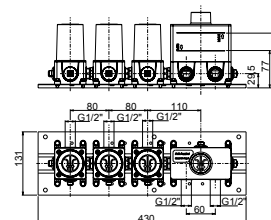

49600V4

Parte esterna visibile incasso termostatico
4 vie, pulsanti con regolazione di portata.
External visible components 4-way
thermostatic built-in mixer with push
button and flow adjustment.

Kit de finition mitigeur 4-voies encastré
thermostatique à poussoir avec
réglage de débit.

Solo parte exterior mezclador termostático
empotrado 4 vías con botón pulsador y
regulación de caudal.

Endmontage Set UP 4 Wege
Thermostat Mischer mit Druckknopf und
Wasserdurchfluss Adjustierung.

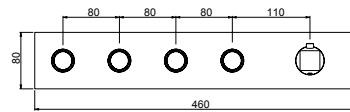

SYSTEM BOX

98600V4

Corpo incasso termostatico 4 vie,
pulsanti con regolazione di portata.
Built-in 4-way push button thermostatic
mixer body with flow adjustment.

Corp encastré 4-voies thermostatique
à poussoir avec réglage de débit.

Cuerpo empotrado 4 vías termostático
con botón pulsador y regulación
de caudal.

UP- Druckknopf 4 Wege Thermostat Körper
mit Wasserdurchfluss Adjustierung.

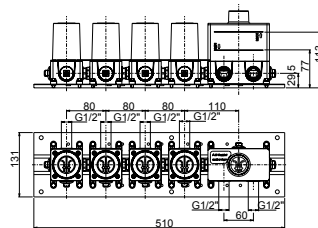

49600V5

Parte esterna visibile incasso termostatico
5 vie, pulsanti con regolazione di portata.
External visible components 5-way
thermostatic built-in mixer with push
button and flow adjustment.

Kit de finition mitigeur 5-voies encastré
thermostatique à poussoir avec
réglage de débit.

Solo parte exterior mezclador termostático
empotrado 5 vías con botón pulsador y
regulación de caudal.

Endmontage Set UP 5 Wege
Thermostat Mischer mit Druckknopf und
Wasserdurchfluss Adjustierung.

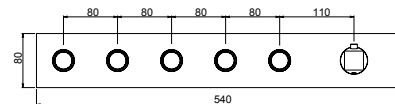
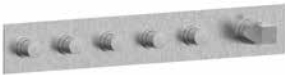

SYSTEM BOX

98600V5

Corpo incasso termostatico 5 vie,
pulsanti con regolazione di portata.
Built-in 5-way push button thermostatic
mixer body with flow adjustment.

Corp encastré 5-voies thermostatique
à poussoir avec réglage de débit.

Cuerpo empotrado 5 vías termostático
con botón pulsador y regulación
de caudal.

UP- Druckknopf 5 Wege Thermostat Körper
mit Wasserdurchfluss Adjustierung.

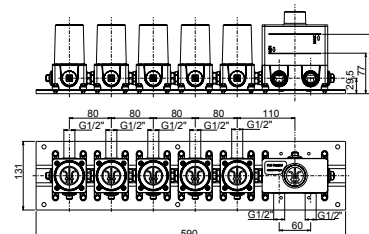

49000V2

Parte esterna visibile incasso meccanico con miscelazione progressiva 2 vie, pulsanti con regolazione di portata.
 External part 2-way for mechanical built-in box push button body with progressive mixing and flow adjustment.
 Kit de finition pour box encastré 2 voies mécanique bouton poussoir avec mélange progressif et réglage de débit.
 Solo parte exterior para box empotrado mecánico 2 vías botón pulsador con mezclado progresivo y regulación de caudal.
 Endmontage Set für mechanische 2 Wege UP-Box Druckknopf mit progressive Mischung und Wasserdurchfluss Adjustierung.

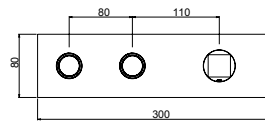

SYSTEM BOX 98000V2

Corpo incasso meccanico con miscelazione progressiva 2 vie, pulsante con regolazione di portata.
 2-Way mechanical built-in box push button body with progressive mixing and flow adjustment.
 Corps encastré 2 voies mécanique bouton poussoir avec mélange progressif et réglage de débit.
 Cuerpo empotrado mecánico 2 vías botón pulsador con mezclado progresivo y regulación de caudal.
 Mechanische 2 Wege UP-Box Druckknopf mit progressive Mischung und Wasserdurchfluss.

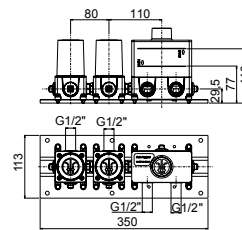

49000V3

Parte esterna visibile incasso meccanico con miscelazione progressiva 3 vie, pulsanti con regolazione di portata.
 External part 3-way for mechanical built-in box push button body with progressive mixing and flow adjustment.
 Kit de finition pour box encastré 3 voies mécanique bouton poussoir avec mélange progressif et réglage de débit.
 Solo parte exterior para box empotrado mecánico 3 vías botón pulsador con mezclado progresivo y regulación de caudal.
 Endmontage Set für mechanische 3 Wege UP-Box Druckknopf mit progressive Mischung und Wasserdurchfluss Adjustierung.

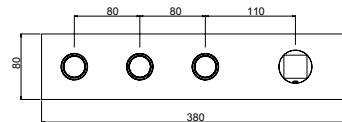

SYSTEM BOX 98000V3

Corpo incasso meccanico con miscelazione progressiva 3 vie, pulsante con regolazione di portata.
 3-Way mechanical built-in box push button body with progressive mixing and flow adjustment.
 Corps encastré 3 voies mécanique bouton poussoir avec mélange progressif et réglage de débit.
 Cuerpo empotrado mecánico 3 vías botón pulsador con mezclado progresivo y regulación de caudal.
 Mechanische 3 Wege UP-Box Druckknopf mit progressive Mischung und Wasserdurchfluss.

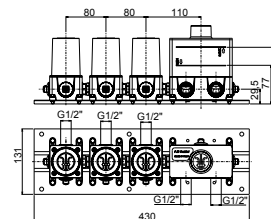

49000V4

Parte esterna visibile incasso meccanico con miscelazione progressiva 4 vie, pulsanti con regolazione di portata.
 External part 4-way for mechanical built-in box push button body with progressive mixing and flow adjustment.
 Kit de finition pour box encastré 4 voies mécanique bouton poussoir avec mélange progressif et réglage de débit.
 Solo parte exterior para box empotrado mecánico 4 vías botón pulsador con mezclado progresivo y regulación de caudal.
 Endmontage Set für mechanische 4 Wege UP-Box Druckknopf mit progressive Mischung und Wasserdurchfluss Adjustierung.

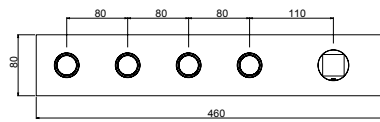

SYSTEM BOX 98000V4

Corpo incasso meccanico con miscelazione progressiva 4 vie, pulsante con regolazione di portata.
 4-Way mechanical built-in box push button body with progressive mixing and flow adjustment.
 Corps encastré 4 voies mécanique bouton poussoir avec mélange progressif et réglage de débit.
 Cuerpo empotrado mecánico 4 vías botón pulsador con mezclado progresivo y regulación de caudal.
 Mechanische 4 Wege UP-Box Druckknopf mit progressive Mischung und Wasserdurchfluss.

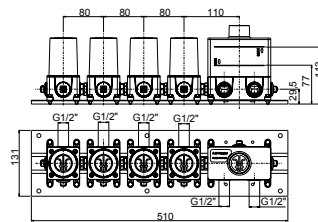

49000V5

Parte esterna visibile incasso meccanico con miscelazione progressiva 5 vie, pulsanti con regolazione di portata.
 External part 5-way for mechanical built-in box push button body with progressive mixing and flow adjustment.
 Kit de finition pour box encastré 5 voies mécanique bouton poussoir avec mélange progressif et réglage de débit.
 Solo parte exterior para box empotrado mecánico 5 vías botón pulsador con mezclado progresivo y regulación de caudal.
 Endmontage Set für mechanische 5 Wege UP-Box Druckknopf mit progressive Mischung und Wasserdurchfluss Adjustierung.

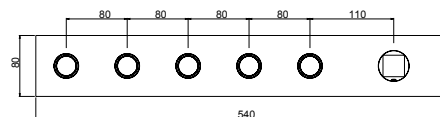

SYSTEM BOX 98000V5

Corpo incasso meccanico con miscelazione progressiva 5 vie, pulsante con regolazione di portata.
 5-Way mechanical built-in box push button body with progressive mixing and flow adjustment.
 Corps encastré 5 voies mécanique bouton poussoir avec mélange progressif et réglage de débit.
 Cuerpo empotrado mecánico 5 vías botón pulsador con mezclado progresivo y regulación de caudal.
 Mechanische 5 Wege UP-Box Druckknopf mit progressive Mischung und Wasserdurchfluss.

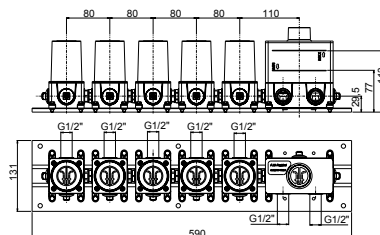

49600

Parte esterna visibile miscelatore
incasso termostatico.

External visible components
thermostatic built-in mixer.

Kit de finition mitigeur encastré
thermostatique.

Solo parte exterior mezclador
termostático empotrado.

Endmontage Set UP
thermostatischer Mischer.

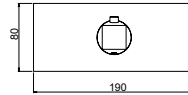

SYSTEM BOX

98600

Corpo incasso miscelatore
termostatico universale.

Thermostatic universal
built-in mixer body.

Corps encastré mitigeur
thermostatique universel.

Cuerpo mezclador universal
termostático empotrado.

UP-thermostatischer Universal Mischer.

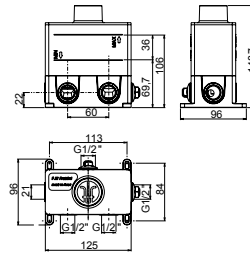

69062

Parte esterna visibile per arresto a
pulsante con regolazione di portata.

External visible components for push
button stop valve with flow adjustment.

Kit de finition pour vanne d'arrêt
à poussoir avec réglage de débit.

Solo parte exterior para válvula de
cierre con botón pulsador y regulación
de caudal.

Endmontage Set für Druckknopf
Absperrventil mit Wasserdurchfluss
Adjustierung.

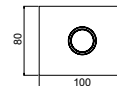

SYSTEM BOX

98062

Corpo incasso arresto a pulsante
con regolazione di portata.

Built-in push button stop valve body
with flow adjustment.

Corp encastré vanne d'arrêt à
poussoir avec réglage de débit.

Cuerpo empotrado válvula de cierre con
botón pulsador con regulación de caudal.

UP- Druckknopf Absperrventil Körper
mit Wasserdurchfluss Adjustierung.

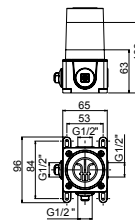



89617
 Doccia saliscendi con
 flessibile 150 cm.
 Sliding rail with handshower
 with 150 cm flexible hose.
 Garniture de douche
 avec flexible 150 cm.
 Barra de ducha completa
 con flexible 150 cm.
 Brausegarnitur mit 150 cm
 Flexibel-Schlauch.

89616
 Presa acqua a muro M 1/2".
 Inlet water connection M 1/2".
 Raccord prise eau M1/2".
 Toma de agua M 1/2".
 Wandanschlussbogen M 1/2".

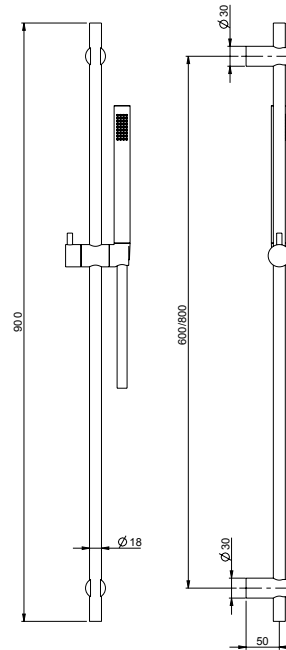

89400
 Supporto con presa acqua da
 incasso con flessibile in silicone
 bianco e doccetta in acciaio inox.
 Inlet water connection with bracket,
 white silicon flexible hose and
 stainless steel handshower.
 Coude murale avec support,
 flexible en silicone blanc et
 douchette en acier inoxydable.
 Toma de agua con soporte, flexible
 de silicone blanco y teleducha en
 acero inoxidable.
 Wandanschlussbogen mit
 Brausehalter, weiß Silikon Schlauch
 und Handbrause aus Edelstahl.

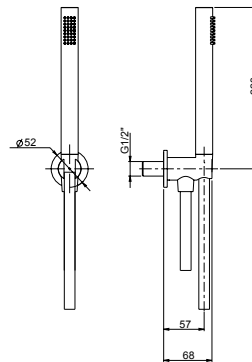

49609

Soffione anticalcareo in acciaio inox 47x24 cm a doppia funzione pioggia e getto crystal.

47x24cm Stainless steel anticalcareous shower head with double function rain and laminar jet.

Pomme de douche en acier inoxydable 47x24 cm anticalcaire avec double fonction pluie et jet laminaire.

Rociador anticalcareo en acero inoxidable 47x24 cm lluvia y flujo laminar.

47x24 cm kalkschutze Regenfall / laminarer Strom Kopfbrause.

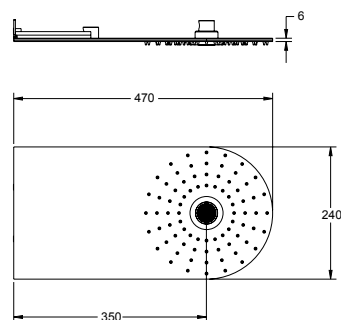

90908

Soffione anticalcareo in acciaio inox da incasso a soffitto 70x40 cm a 3 funzioni: pioggia, due cascate, nebulizzazione con cromoterapia, dotato di **pulsantiera** (7,5x15 cm) controllo luci interno al box doccia.

70x40 cm stainless steel anticalcareous ceiling mounted shower with 3 functions: rainfall + 2 waterfall. Nebulizer with chromo therapy with light control *push-button panel* inside the shower box (7,5x15 cm).

Douche anticalcaire en acier inoxydable au plafond 70x40 cm avec 3 fonctions: pluie et deux cascades. Nébulisation avec chromothérapie avec *bouton poussoir commande lumières* à l'intérieur du box de douche (7,5x15 cm).

Rociador anticalcareo en acero inoxidable empotrado a techo 70x40 cm 3 función: lluvia y 2 cascadas, pulverización con cromoterapia con *pulsadores* para el control de la luz interno de la cabina de ducha (7,5x15 cm).

Kalkschutze UP-Brause aus Edelstahl Decke Montage 70x40 cm mit 3 Funktion: Regen + 2 Wasserfall. Zerstäubung mit Farbtherapie mit *Leuchten Betätigung* innen der Duschkabine (7,5x15 cm).

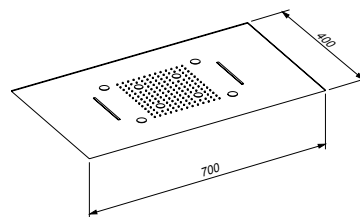
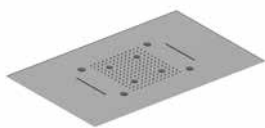



90911

Soffione anticalcareo in acciaio inox da incasso a soffitto 55x40 cm a tre funzioni: pioggia, cascata e nebulizzazione.

55x40 cm stainless steel anticalcareous ceiling mounted shower with 3 functions: rainfall, waterfall and nebulizer.

Douche anticalcaire en acier inoxydable au plafond 55x40 cm avec 3 fonctions: pluie, cascade et nébulisation.

Rociador anticalcareo en acero inoxidable empotrado a techo 55x40 cm 3 función: lluvia, cascada y pulverización.

Kalkschutze UP-Brause aus Edelstahl Decke Montage 55x40 cm mit 3 Funktion: Regen Wasserfall und Zerstäubung.

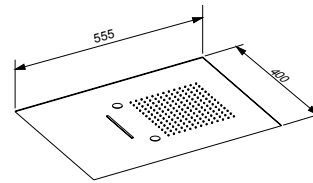

90895

Bocca cascata 23x5 cm a muro in acciaio inox.

23x5 cm stainless steel wall-mounted waterfall spout.

Bec au mur à cascade 23x5 cm en acier inoxydable.

Caño a cascada 23x5 cm de pared en acero inoxidable.

Wasserfall Auslauf 23x5 cm aus Edelstahl.

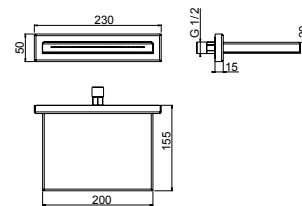

90894

Bocca cascata 20x12,2 cm a muro in acciaio inox.

20x12,2 cm stainless steel wall-mounted waterfall spout

Bec au mur à cascade 20x12,2 cm en acier inoxydable.

Caño a cascada 20x12,2 cm de pared en acero inoxidable.

Wasserfall Auslauf 20x12,2 cm aus Edelstahl.

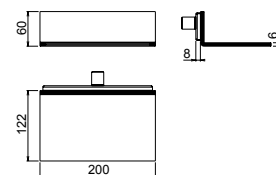



90891

Soffione cascata 27x5 cm
 filo parete in acciaio inox.
 27x5 cm stainless steel
 wall-mounted shower with waterfall.
 Douche au mur en acier inoxydable
 27x5 cm à cascade .
 Rociador a cascada en acero
 inoxidable 27x5 cm de pared.
 Wasserfall Brause aus Edelstahl
 27x5 cm.

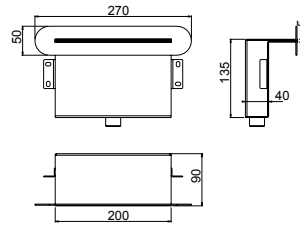

90892

Soffione cascata 27x5 cm
 filo parete in acciaio inox.
 27x5 cm stainless steel wall-mounted
 shower with waterfall.
 Douche au mur 27x5 cm
 à cascade en acier inoxydable.
 Rociador a cascada 27x5 cm
 de pared en acero inoxidable.
 Wasserfall Brause 27x5 cm
 aus Edelstahl.

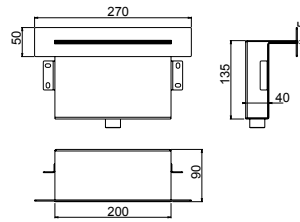

69850

Soffioncino laterale cilindrico
 orientabile autopulente Ø 5,2 cm
 anticalcareo in acciaio inox 1/2" F.
 ½" F stainless steel anticalcareous
 Ø 5,2 cm cylindric adjustable
 and self-cleaning body-jet shower.
 Douchette latérale cylindrique
 amovible et autonettoyante
 Ø 5,2 cm anticalcaire en acier
 inoxydable ½ »F.
 Ducha lateral ½ »F cilndrica y
 autolimpiezante Ø 5,2 cm
 anticalcareo en acero inoxidable.
 Kalkschutze Seitenbrause ½" F
 zylindrisch Ø 5,2 cm, schwenkbar
 und selbst-reinigend aus Edelstahl.

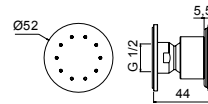



89850

Soffioncino laterale cilindrico orientabile autopulente 5,2x5,2 cm anticalcareo in acciaio inox 1/2" F.
1/2" F stainless steel anticalcareous 5,2x5,2 cm cylindric adjustable and self-cleaning body-jet shower.
Douchette latérale cylindrique amovible et autonettoyante 5,2x5,2 cm anticalcaire en acier inoxydable 1/2" F.
Ducha lateral 1/2" F cilíndrica y autolimpiezante 5,2x5,2 cm anticalcareo en acero inoxidable.
Kalkschutze Seitenbrause 1/2" F zylindrisch 5,2x5,2 cm, schwenkbar und selbst-reinigend aus Edelstahl.

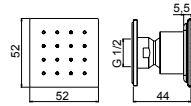

89930

Braccio doccia a parete L 350 in acciaio inox.
Stainless steel shower arm.
Bras de douche en acier inoxydable.
Rociador en acero inoxidable.
Brausearm aus Edelstahl.

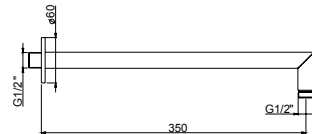

89940

Braccio verticale L 300 in acciaio inox.
Stainless steel vertical arm.
Bras vertical en acier inoxydable.
Brazo vertical en acero inoxidable.
Vertikalem Arm aus Edelstahl.

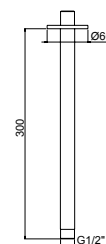



90982
 Placca cassetta WC
 compatibile Geberit.
 Plate for toilet cistern
 Geberit compatible.
 Plaque pour citerne de
 toilette compatible Geberit.
 Placa para cisterna de WE
 compatible con Geberit.
 Platte für Spülkasten
 Geberit kompatibel.

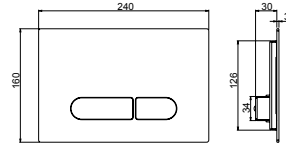

Compatibilità con cassetta di
 scarico Geberit Sigma 8.
 Compatible with Geberit
 Sigma 8 toilet cistern.
 Compatible avec citerne de
 vidage toilette Geberit Sigma 8.
 Compatible con cisterna de
 descargo Geberit Sigma 8.
 Kompatibel mit Geberit
 Sigma 8 Spülkasten.



69400
 Idroscopino con flessibile e supporto
 attacco incasso a muro con chiusura.
 Waterspray with flexible hose
 and built-in bracket with on/off.
 Hydro-douchette avec tuyau
 flexible et coude support
 encastré avec fermeture.
 Hydro-teleducha con flexible
 y soporte empotrado con cierre.
 Wasser Spray mit Flex Schlauch und
 Wandschlussbogen mit Halter und
 Schließung.

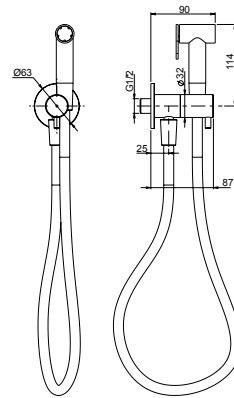

69401
 Doccetta con flessibile e supporto
 attacco incasso a muro con chiusura.
 Handshower with flexible hose
 and built-in bracket with on/off.
 Douchette avec tuyau flexible et
 coude support encastré avec
 fermeture.
 Teleducha con flexible y soporte
 empotrado con cierre.
 Handbrause mit Flex Schlauch und
 Wandschlussbogen mit Halter und
 Schließung.

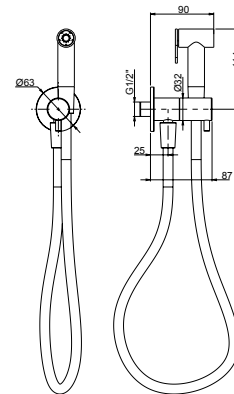



69500
 Parte estetica miscelatore
 monocomando idroscopino.
 External part single lever
 water spray handshower mixer.
 Kit de finition mitigeur
 monocommande hydro-douchette.
 Solo parte exterior mezclador
 monomando hydro-teleducha.
 Endmontage Set Wasser Spray
 Handbrause Einhebel Mischer.

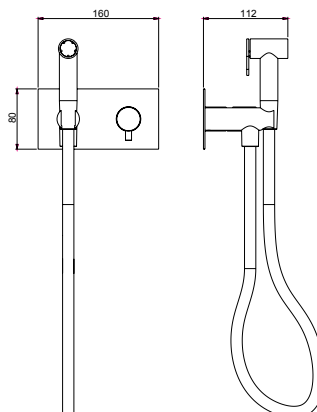

69501
 Parte estetica miscelatore
 monocomando doccia.
 External part single lever
 handshower mixer.
 Kit de finition mitigeur
 monocommande douchette.
 Solo parte exterior mezclador
 monomando teleducha.
 Endmontage Set Einhebel
 Handbrause Mischer.

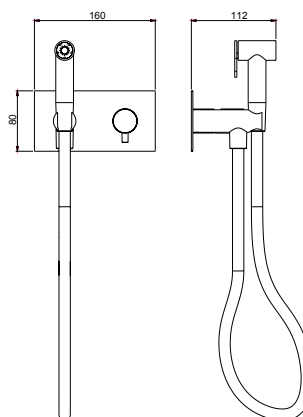

SYSTEM BOX
 98500
 Corpo per monocomando incasso
 doccia/idroscopino universale,
 cartuccia Ø25.
 Universal built-in box for single lever
 handshower water spray mixer,
 cartridge Ø25.
 Corps à encastrer pour
 monocommande hydro-douchette
 universel, cartouche Ø25.
 Cuerpo universal empotrado para
 monomando hydro-teleducha,
 cartucho Ø 25.
 UP-Box für Einhebel Wasser Spray
 Mischer Kartusche D.25.

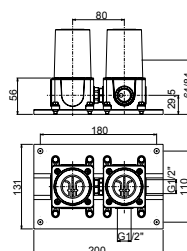

Frattini[®]

RUBINETTI DAL 1958

Frattini dal 1958 disegna, affina ed evolve forme e funzioni della rubinetteria per dare vita ad oggetti che definiscono gli stili dell'abitare nella sala da bagno e nella cucina. La passione, l'esperienza e l'innovazione accompagnano la missione dell'azienda presente in tutto il mondo. Oggi è guidata dalla seconda generazione ed è proiettata verso il futuro con l'impegno di mantenere viva la storia ed i valori di famiglia, nel cuore e nell'impresa.

Since 1958 Frattini has been designing, refining and evolving the shapes and functions of taps, to give life to objects that define living styles in the bathroom and kitchen. Passion, experience and innovation accompany the mission of the company throughout the world. Today it is led by the second generation and is projected towards the future with the commitment to keeping the family history and values alive, in the heart and in the business.



Litri al minuto
Liters per minute



Inox 316L

Nei migliori showroom di arredo bagno.
In the best bathroom furniture showrooms.



www.frattini.it

Frattini
RUBINETTI DAL 1958

Rubinerie Fratelli Frattini S.p.A.
Via Roma, 125 . 28017 San Maurizio d'Opaglio (NO) Italy
Tel. +39 0322 96127 . 96128 . Fax +39 0322 967272
info@frattini.it . ordini@frattini.it . export@frattini.it



#fratellifrattini