

REVOLUTION



Pratica

Facile e veloce da installare, anche senza lavori di muratura. La migliore soluzione per la sostituzione di una vecchia vasca o cabina doccia.

Sicurezza e solidità

La garanzia tecnica di un progetto sviluppato dall'ufficio sviluppo di una grande azienda.

Diverse proposte di configurazione

Massima funzionalità per il tuo bagno.
Massima opportunità di configurazione per un bagno elegante e coordinato.

Novellini facilita il montaggio

Contattaci per capire la semplicità di montaggio del nostro prodotto.

TRATTAMENTI



Hai bisogno di riorganizzare il tuo bagno o semplicemente rinnovarlo? Revolution è la soluzione più adatta alle tue esigenze. Grazie alle molteplici misure e soluzioni, è la cabina doccia ideale per le ristrutturazioni e perfetta per la sostituzione della vasca.



REVOLUTION

REVOLUTION è...

Una **cabina**
con **box doccia**



Una **cabina doccia**
con **colonna porta-lavatrice**
e **porta-biancheria**



Una **cabina**
con **spazio doccia**



Un bagno coordinato a 360°



Una cabina doccia con colonna porta-lavatrice e asciugatrice



Una cabina doccia con colonna multifunzione

REVOLUTION CON BOX DOCCIA

UN SOLO CODICE PER ORDINARE IL KIT COMPRENSIVO DI:

- BOX DOCCIA ZEPHYROS 2P (FINITURA CROMO, VETRO TRASPARENTE)
- PIATTO DOCCIA OLYMPIC PLUS H. 12,5 CM BIANCO LUCIDO
- PARETI INTERNE IN VETRO BIANCO



REVOLUTION

LARGHEZZA 140

Parete posteriore bassa

Misure	Codice		Codice	
140 X 70	KREAC1472P-1K		KREAA1472P-1K	
140 X 75	KREAC1452P-1K		KREAA1452P-1K	
140 X 80	KREAC1482P-1K		KREAA1482P-1K	

Parete posteriore alta

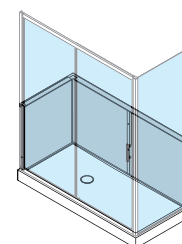

Parete posteriore bassa

LARGHEZZA 160

Parete posteriore bassa

Misure	Codice		Codice	
160 X 70	KREAC1672P-1K		KREAA1672P-1K	
160 X 75	KREAC1652P-1K		KREAA1652P-1K	
160 X 80	KREAC1682P-1K		KREAA1682P-1K	

Parete posteriore alta

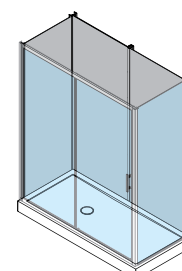

Parete posteriore alta

LARGHEZZA 170

Parete posteriore bassa

Misure	Codice		Codice	
170 X 70	KREAC1772P-1K		KREAA1772P-1K	
170 X 75	KREAC1752P-1K		KREAA1752P-1K	
170 X 80	KREAC1782P-1K		KREAA1782P-1K	

Parete posteriore alta

REVOLUTION CON SPAZIO DOCCIA

UN SOLO CODICE PER ORDINARE IL KIT COMPRENSIVO DI:

- SPAZIO DOCCIA GIADA H (FINITURA CROMO, VETRO TRASPARENTE)
- PIATTO DOCCIA OLYMPIC PLUS H. 12,5 CM BIANCO LUCIDO
- PARETI INTERNE IN VETRO BIANCO



LARGHEZZA 140

Parete posteriore bassa

Parete posteriore alta

Misure	Codice		Codice	
140 X 70	KREAC147HH-1K		KREAA147HH-1K	
140 X 75	KREAC145HH-1K		KREAA145HH-1K	
140 X 80	KREAC148HH-1K		KREAA148HH-1K	

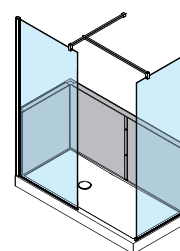

Parete posteriore bassa

LARGHEZZA 160

Parete posteriore bassa

Parete posteriore alta

Misure	Codice		Codice	
160 X 70	KREAC167HH-1K		KREAA167HH-1K	
160 X 75	KREAC165HH-1K		KREAA165HH-1K	
160 X 80	KREAC168HH-1K		KREAA168HH-1K	

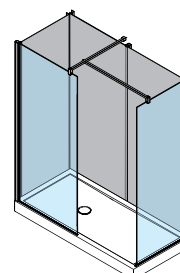

Parete posteriore alta

LARGHEZZA 170

Parete posteriore bassa

Parete posteriore alta

Misure	Codice		Codice	
170 X 70	KREAC177HH-1K		KREAA177HH-1K	
170 X 75	KREAC175HH-1K		KREAA175HH-1K	
170 X 80	KREAC178HH-1K		KREAA178HH-1K	



REVOLUTION

REVOLUTION CON MOBILE MULTIFUNZIONE

UN SOLO CODICE PER ORDINARE IL KIT COMPRENSIVO DI:

- BOX DOCCIA ZEPHYROS 2P (FINITURA CROMO, VETRO TRASPARENTE)
- PIATTO DOCCIA NEW OLYMPIC BIANCO LUCIDO
- PARETI INTERNE IN VETRO BIANCO

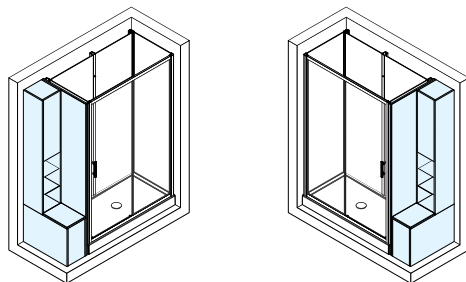

Misure	COLONNA BIANCA SINISTRA		COLONNA BIANCA DESTRA	
	Codice		Codice	
170 X 70	KREAA1772P08-1KA		KREAA1772P05-1KA	
170 X 80	KREAA1782P10-1KA		KREAA1782P07-1KA	

	COLONNA BURLINGTON SINISTRA		COLONNA BURLINGTON DESTRA	
	Codice		Codice	
170 X 70	KREAA1772P08-1KN		KREAA1772P05-1KN	
170 X 80	KREAA1782P10-1KN		KREAA1782P07-1KN	

OPTIONAL

PANNELLO DI TAMPONAMENTO (5-25 cm) H 206,5 cm (sagomabile su misura)

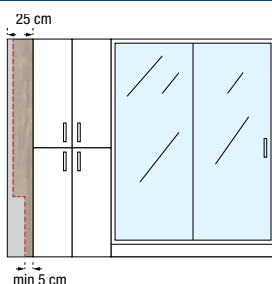

Finitura	Codice	
Bianco	REV006A	
Bianco rigato	REV006I	
Burlington	REV006N	
Grain	REV006M	
Wenge	REV006V	

Il pannello di tamponamento è sagomabile e consente l'installazione di Revolution anche in presenza di ostacoli in muratura o di impiantistica sulla parete.

La misura minima dopo la sagomatura è di 50 mm.



REVOLUTION

REVOLUTION CON MOBILE PORTA-LAVATRICE O PORTA-LAVATRICE E ASCIUGATRICE

UN SOLO CODICE PER ORDINARE IL KIT COMPRENSIVO DI:

- BOX DOCCIA ZEPHYROS 2P (FINITURA CROMO, VETRO TRASPARENTE)
- PIATTO DOCCIA NEW OLYMPIC BIANCO LUCIDO
- PARETI INTERNE IN VETRO BIANCO
- COLONNA PORTA-LAVATRICE O PORTA-LAVATRICE E ASCIUGATRICE

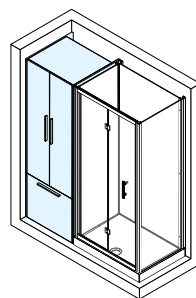

Misure	COLONNA PORTA LAVATRICE BIANCA		COLONNA PORTALAVATRICE BURLINGTON	
	Codice		Codice	
170 X 70	KREAA177S001-1KA		KREAA177S001-1KN	
170 X 80	KREAA178S002-1KA		KREAA178S002-1KN	

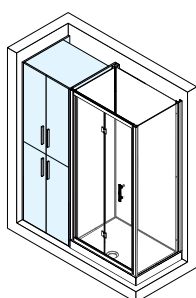

	COLONNA PORTA LAVATRICE E ASCIUGATRICE BIANCA		COLONNA PORTA LAVATRICE E ASCIUGATRICE BURLINGTON	
	Codice		Codice	
170 X 70	KREAA177S003-1KA		KREAA177S003-1KN	
170 X 80	KREAA178S004-1KA		KREAA178S004-1KN	

OPTIONAL

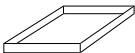
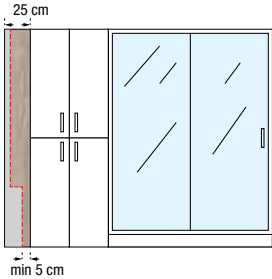
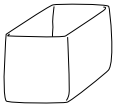
ACCESSORI COLONNA		PANNELLO DI TAMPONAMENTO (5-25 cm) H 206,5 cm (sagomabile su misura)													
	VASSOIO PORTA DETERSIVI 200 x 460 x H 30 Codice REVB11A		<table border="1"> <thead> <tr> <th>Finitura</th> <th>Codice</th> </tr> </thead> <tbody> <tr> <td>Bianco</td> <td>REVO06A</td> </tr> <tr> <td>Bianco rigato</td> <td>REVO06I</td> </tr> <tr> <td>Burlington</td> <td>REVO06N</td> </tr> <tr> <td>Grain</td> <td>REVO06M</td> </tr> <tr> <td>Wenge</td> <td>REVO06V</td> </tr> </tbody> </table>	Finitura	Codice	Bianco	REVO06A	Bianco rigato	REVO06I	Burlington	REVO06N	Grain	REVO06M	Wenge	REVO06V
Finitura	Codice														
Bianco	REVO06A														
Bianco rigato	REVO06I														
Burlington	REVO06N														
Grain	REVO06M														
Wenge	REVO06V														
	PORTA BIANCHERIA 360 x 460 x H 360 Codice REVB11B														

MOBILI COORDINATI



FINITURA LACCATO



Bianco lucido

FINITURA LEGNO



Bianco rigato

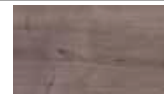

Burlington

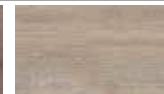

Grain

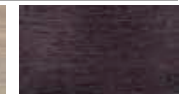

Wenge

BASE PORTALAVABO

con due cassetti con sponde in metallo e guide Hettich con soft closing

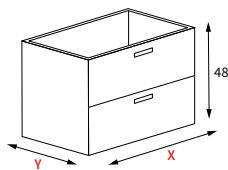

Misure		Codice	Scelta finitura / prezzo				
Larghezza	Profondità		A	I	N	M	V
X	Y		Bianco lucido	Bianco rigato	Burlington	Grain	Wenge
60	45	L4CNTP60					
70	45	L4CNTP70					
90	45	L4CNTP90					
60	50	L4CNCP60					
70	50	L4CNCP70					
90	50	L4CNCP90					

CONSOLLE ZEN

in Mineralsolid bianco lucido

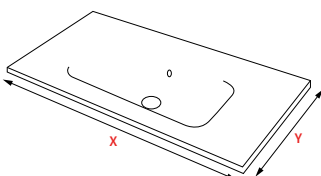

Misure		Misure vaschetta		Codice	Prezzo
Larghezza	Profondità	Larghezza	Profondità		
X	Y				
61	46	55	31	L99L1912	
71	46	60	31	L99L1913	
91	46	60	31	L99L1914	
61	50	52	31	L99L1915	
71	50	55	31	L99L1916	
91	50	62	31	L99L1917	

CONSOLLE QUBO

in Ceramica

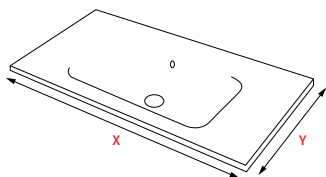

Misure		Misure vaschetta		Codice
Larghezza	Profondità	Larghezza	Profondità	
X	Y			
61	46	46,7	27,8	L99L1907
71	46	56,7	27,8	L99L1908
91	46	56,7	27,8	L99L1909
61	51	46,7	33	L99L1910
71	51	57	33	L99L1904
91	51	57	33	L99L1911

COLONNE

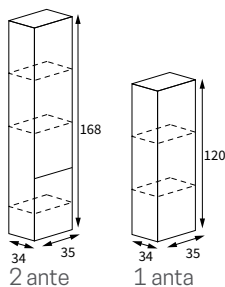

Misure	Apertura	Codice	Scelta finitura / prezzo				
Altezza	Lato cerniere		A	I	N	M	V
			Bianco lucido	Bianco rigato	Burlington	Grain	Wenge
120	Destra	D4CCB1CB					
120	Sinistra	S4CCB1CB					
168	Destra	D4CCB3CD					
168	Sinistra	S4CCB3CD					

PENSILI

1 anta

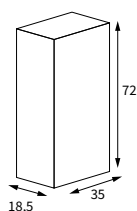

Codice		Scelta finitura / prezzo				
Lato cerniere		A	I	N	M	V
		Bianco lucido	Bianco rigato	Burlington	Grain	Wenge
Destra	D4CPA1C6					
Sinistra	S4CPA1C6					

SPECCHI

lisci o retroilluminati LED 4 lati

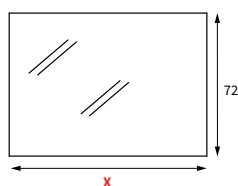

Misure	Codice	Prezzo	Misure	Codice	Prezzo
Larghezza	Liscio		Larghezza	Retroilluminato led	
X			X		
60	L4AS1260		60	L4AS2260	
70	L4AS1270		70	L4AS2270	
90	L4AS1290		90	L4AS2290	

LAMPADE

non abbinabile a specchio a led



Misure	Descrizione	Montaggio	Codice	Prezzo
Larghezza				
30	4,8 W.220V.IP44	-Orizzontale/verticale /muro	L4BA4487	
20	6 W.220V.IP44	-Orizzontale/verticale /muro	L4BA4493	

MODULO D'ORDINE

COME PERSONALIZZARE LA TUA REVOLUTION IN 4 MOSSE



1	PIATTO DOCCIA p. 463	COD.
	ZEPHYROS 2P	COD.
2	BOX DOCCIA p. 464	COD.
	ZEPHYROS 2A	COD.
	ZEPHYROS F	COD.
	GIADA H1	COD.
2	SPAZIO DOCCIA p. 466	COD.
	GIADA H2	COD.
	GIADA HA	COD.
3	PANNELLI A MURO p. 467	COD.
	COLONNA	COD.
	SEDILE	COD.
	SPECCHIO	COD.
4	ACCESSORI p. 468	COD.
	POGGIAPIEDI	COD.
	MANIGLIONE	COD.
	SCATOLA PER ALLACCI IDRAULICI	COD.

1 PIATTO DOCCIA - OLYMPIC PLUS

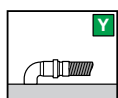
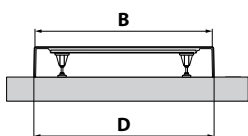
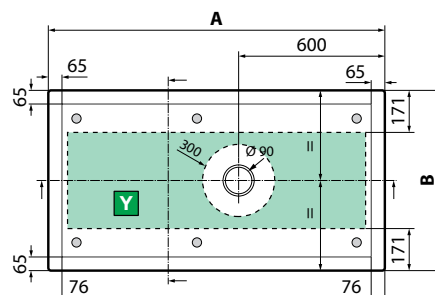
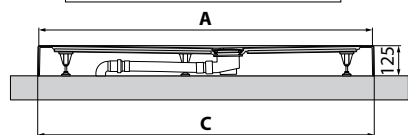
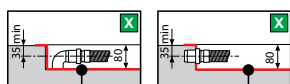
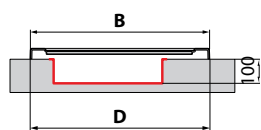
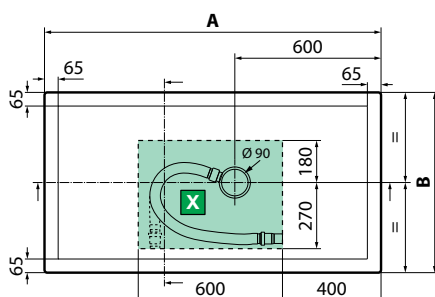
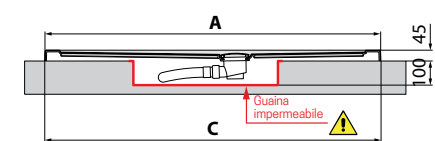

X Zona incassata a pavimento per lo scarico H 100

Y Zona disponibile per lo scarico sopra pavimento

SPESSORE 4,5 CM

con antiscivolo (PN24)

Misure	Codice	Scelta finitura / Prezzo						Codice	Prezzo
		30	79	11	27	29	28		
		Bianco	Bianco morbido	Beige	Corda	Grigio	Nero		Bianco
AxB * ± 2 mm	CxD ** ± 3 mm								
110 x 70	1094 x 692	1096 x 694	OL110704-						
110 x 80	1094 x 792	1096 x 794	OL110804-						
120 x 70	1194 x 692	1196 x 694	OL120704-					OL120704A-	
120 x 80	1194 x 792	1196 x 794	OL801204-						
120 x 90	1194 x 892	1196 x 894	OL120904-					OL120904A-	
120 x 100	1194 x 992	1196 x 994	OL120104-					OL120104A-	
140 x 70	1392 x 692	1394 x 694	OL140704-					OL140704A-	
140 x 75	1392 x 742	1394 x 744	OL140754-					OL140754A-	
140 x 80	1392 x 792	1394 x 794	OL140804-					OL140804A-	
140 x 90	1392 x 892	1394 x 894	OL140904-					OL140904A-	
140 x 100	1392 x 992	1394 x 994	OL140104-					OL140104A-	
150 x 70	1492 x 692	1494 x 694	OL150704-					OL150704A-	
150 x 75	1492 x 742	1494 x 744	OL150754-					OL150754A-	
160 x 70	1592 x 692	1594 x 694	OL160704-					OL160704A-	
160 x 75	1592 x 742	1594 x 744	OL160754-					OL160754A-	
160 x 80	1592 x 792	1594 x 794	OL160804-					OL160804A-	
160 x 90	1592 x 892	1594 x 894	OL160904-					OL160904A-	
170 x 70	1692 x 692	1694 x 694	OL170704-					OL170704A-	
170 x 75	1692 x 742	1694 x 744	OL170754-					OL170754A-	
170 x 80	1692 x 792	1694 x 794	OL170804-					OL170804A-	
170 x 90	1692 x 892	1694 x 894	OL170904-					OL170904A-	
180 x 75	1792 x 742	1794 x 744	OL180754-					OL180754A-	
180 x 80	1792 x 792	1794 x 794	OL180804-					OL180804A-	
180 x 90	1792 x 892	1794 x 894	OL180904-						

SPESSORE 12,5 CM

con antiscivolo (PN24)

Misure	Codice	Scelta finitura / Prezzo						Codice	Prezzo
		30	79	11	27	29	28		
		Bianco	Bianco morbido	Beige	Corda	Grigio	Nero		Bianco
AxB * ± 2 mm	CxD ** ± 3 mm								
110 x 70	1094 x 692	1100 x 698	OL1107011-						
110 x 80	1094 x 792	1100 x 798	OL1108011-						
120 x 70	1194 x 692	1200 x 698	OL1207011-					OL1207011A-	
120 x 80	1194 x 792	1200 x 798	OL8012011-					OL8012011A-	
120 x 90	1194 x 892	1200 x 898	OL1209011-					OL1209011A-	
120 x 100	1194 x 992	1200 x 998	OL1201011-					OL1201011A-	
140 x 70	1392 x 692	1398 x 698	OL1407011-					OL1407011A-	
140 x 75	1392 x 742	1398 x 748	OL1407511-					OL1407511A-	
140 x 80	1392 x 792	1398 x 798	OL1408011-					OL1408011A-	
140 x 90	1392 x 892	1398 x 898	OL1409011-					OL1409011A-	
140 x 100	1392 x 992	1398 x 998	OL1401011-					OL1401011A-	
150 x 70	1492 x 692	1498 x 698	OL1507011-					OL1507011A-	
150 x 75	1492 x 742	1498 x 748	OL1507511-					OL1507511A-	
160 x 70	1592 x 692	1598 x 698	OL1607011-					OL1607011A-	
160 x 75	1592 x 742	1598 x 748	OL1607511-					OL1607511A-	
160 x 80	1592 x 792	1598 x 798	OL1608011-					OL1608011A-	
160 x 90	1592 x 892	1598 x 898	OL1609011-					OL1609011A-	
170 x 70	1692 x 692	1698 x 698	OL1707011-					OL1707011A-	
170 x 75	1692 x 742	1698 x 748	OL1707511-					OL1707511A-	
170 x 80	1692 x 792	1698 x 798	OL1708011-					OL1708011A-	
170 x 90	1692 x 892	1698 x 898	OL1709011-					OL1709011A-	
180 x 75	1792 x 742	1798 x 748	OL1807511-					OL1807511A-	
180 x 80	1792 x 792	1798 x 798	OL1808011-					OL1808011A-	
180 x 90	1792 x 892	1798 x 898	OL1809011-						

2 BOX DOCCIA



PORTE

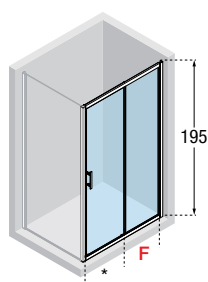

Reversibile

ZEPHYROS 2P Installabile in nicchia, con fisso laterale o centro parete

Misure				Codice	Scelta vetro				Scelta Profilo /Prezzo			
Larghezza piatto	Estensibilità	Fisso	Entrata		1	68	11	54	A	B	K	H
		F	*		Trasparente	Serigrafia Zephyros 1	Niva	Fumè	Bianco	Silver	Cromo	Nero opaco
120	116↔122	55	47	ZEPHYR2P116-								
140	136↔142	65	57	ZEPHYR2P136-								

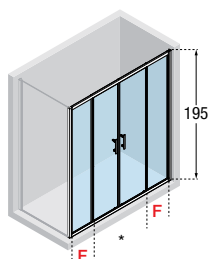

Reversibile

ZEPHYROS 2A Installabile in nicchia, con fisso laterale o centro parete

Misure				Codice	Scelta vetro				Scelta Profilo /Prezzo			
Larghezza piatto	Estensibilità	Fisso	Entrata		1	68	11	54	A	B	K	H
		F	*		Trasparente	Serigrafia Zephyros 1	Niva	Fumè	Bianco	Silver	Cromo	Nero opaco
160	156↔162	37	59	ZEPHYR2A156-								
170	166↔172	40	64	ZEPHYR2A166-								
180	176↔182	42	69	ZEPHYR2A176-								

PER INSTALLAZIONE IN NICCHIA

Disegni tecnici per l'installazione vedi pag. 479

Quando la misura della nicchia è maggiore della estensibilità STANDARD ordinare i PROFILI DI COMPENSAZIONE (vedi paragrafo in fondo alla pagina)

PER INSTALLAZIONE AD ANGOLO

Disegni tecnici per l'installazione vedi pag. 479

ORDINARE 1 PANNELLO FISSO LATERALE

ZEPHYROS F

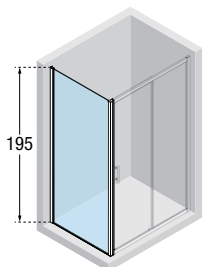

Reversibile

Misure		Codice	Scelta vetro				Scelta Profilo /Prezzo			
Profondità piatto	Estensibilità		1	68	11	54	A	B	K	H
			Trasparente	Serigrafia Zephyros 1	Niva	Fumè	Bianco	Silver	Cromo	Nero opaco
70	68↔71	ZEPHYRF68-								
75	73↔76	ZEPHYRF73-								
80	78↔81	ZEPHYRF78-								
90	88↔91	ZEPHYRF88-								

PER INSTALLAZIONE A CENTRO PARETE

Disegni tecnici per l'installazione vedi pag. 479

ORDINARE 2 PANNELLI FISSI LATERALI

ZEPHYROS F

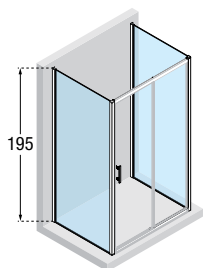

Reversibile

Misure		Codice	Scelta vetro				Scelta Profilo /Prezzo			
Profondità piatto	Estensibilità		1	68	11	54	A	B	K	H
			Trasparente	Serigrafia Zephyros 1	Niva	Fumè	Bianco	Silver	Cromo	Nero opaco
70	68↔71	ZEPHYRF68-								
75	73↔76	ZEPHYRF73-								
80	78↔81	ZEPHYRF78-								
90	88↔91	ZEPHYRF88-								

PROFILO DI COMPENSAZIONE

disegni tecnici per l'installazione vedi pag. 479

PROFILO DI COMPENSAZIONE + 15 mm

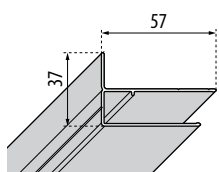

Profilo	Codice	Prezzo
Bianco	P05BHCST-A	
Silver	P05BHCST-B	
Cromo	P05BHCST-K	
Nero opaco	P05BHCST-H	

PROFILO DI COMPENSAZIONE A SCATTO + 25 mm

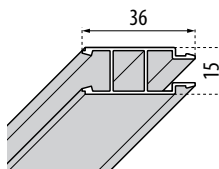

Profilo	Codice	Prezzo
Bianco	P05HAAST3-A	
Silver	P05HAAST3-B	
Cromo	P05HAAST3-K	
Nero opaco	P05HAAST3-H	

PROFILO DI COMPENSAZIONE PER GIADA H + 15 mm

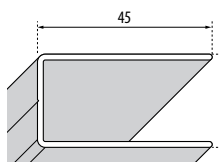

Profilo	Codice	Prezzo
Bianco	P01BLMOST-A	
Silver	P01BLMOST-B	
Cromo	P01BLMOST-K	

PANNELLO DI TAMPONAMENTO

sagomabile a misura (5-25 cm) H 207,5 cm

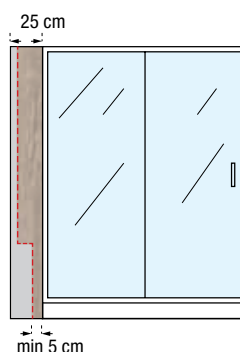

Il pannello di tamponamento è sagomabile e consente l'installazione di Revolution anche in presenza di ostacoli in muratura o di impiantistica sulla parete.

La misura minima dopo la sagomatura è di 50 mm.

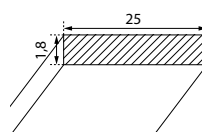

Finitura	Codice	Prezzo
Bianco	REVO07A	
Bianco rigato	REVO07I	
Burlington	REVO07N	
Grain	REVO07M	
Wenge	REVO07V	

2 SPAZIO DOCCIA INSTALLABILE SOLO NELLA VERSIONE AD ANGOLO

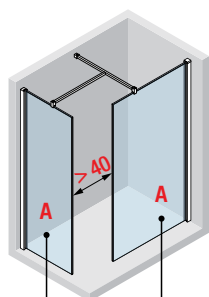

GIADA H
LATO CORTO **GIADA H**
LATO LUNGO

Per realizzare questa
composizione ordinare 2 pezzi,
uno per lato

Reversibile

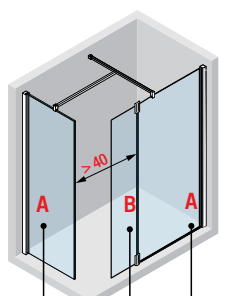

GIADA H
LATO CORTO **GIADA H**
LATO LUNGO

GIADA HA
ANTINA GIREVOLE

Per realizzare questa composizione
ordinare 3 pezzi:
uno per lato + antina girevole HA

Reversibile

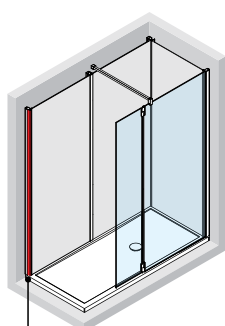

KIT DI FINITURA

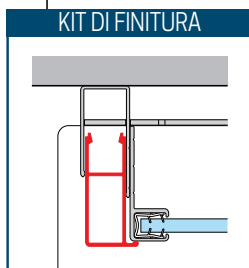

GIADA H LATO LUNGO

Disegni tecnici per l'installazione vedi pag. 479

Misure		Codice	Scelta vetro		Scelta finitura / Prezzo		
Misura consigliata piatto	Misura filo lastra		1	44	A	B	K
Larghezza	A		Trasparente	Band Satin	Bianco	Silver	Cromo
120	67↔68,5	GIADAH70-					
	77↔78,5	GIADAH80-					
140	87↔88,5	GIADAH90-					
160	107↔108,5	GIADAH110-					
170	117↔118,5	GIADAH120-					
180	127↔128,5	GIADAH130-					

GIADA H LATO CORTO

Disegni tecnici per l'installazione vedi pag. 479

Misure		Codice	Scelta vetro		Scelta finitura / Prezzo		
Misura consigliata piatto	Misura filo lastra		1	44	A	B	K
Larghezza	A		Trasparente	Band Satin	Bianco	Silver	Cromo
70	67↔68,5	GIADAH70-					
75	72↔73,5	GIADAH75-					
80	77↔78,5	GIADAH80-					
90	87↔88,5	GIADAH90-					

GIADA HA ANTINA GIREVOLE

Misure		Codice	Scelta vetro		K
Misura consigliata piatto	Misura effettiva d'ingombro		1		
Larghezza	B		Trasparente		Cromo
70	37	GIADAH37-			

Per versione senza GIADA H LATO CORTO ordinare il KIT DI FINITURA

Profilo	Codice
Bianco	P51REGHST-A
Silver	P51REGHST-B
Cromo	P51REGHST-K

3 PANNELLI A MURO

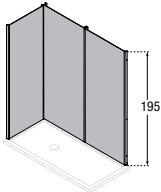
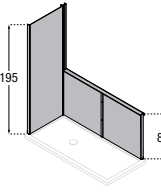
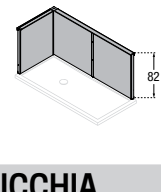
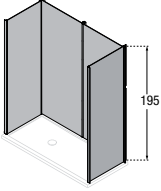
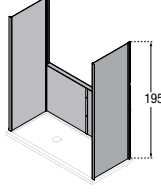
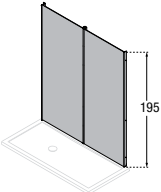
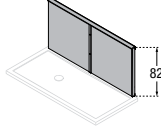
COMBINAZIONI	Profondità	Larghezza / codice					Bianco	Nero	Prezzo	
		120 cm	140 cm	160 cm	170 cm	180 cm	-A	-H		
ANGOLO										
	70	REVAA12070	REVAA14070	REVAA16070	REVAA17070	-				
	75	-	REVAA14075	REVAA16075	REVAA17075	REVAA18075				
	80	REVAA12080	REVAA14080	REVAA16080	REVAA17080	REVAA18080				
	90	REVAA12090	REVAA14090	REVAA16090	REVAA17090	-				
	70	REVAB12070	REVAB14070	REVAB16070	REVAB17070	-				
	75	-	REVAB14075	REVAB16075	REVAB17075	REVAB18075				
	80	REVAB12080	REVAB14080	REVAB16080	REVAB17080	REVAB18080				
	90	REVAB12090	REVAB14090	REVAB16090	REVAB17090	-				
	70	REVAC12070	REVAC14070	REVAC16070	REVAC17070	-				
	75	-	REVAC14075	REVAC16075	REVAC17075	REVAC18075				
	80	REVAC12080	REVAC14080	REVAC16080	REVAC17080	REVAC18080				
	90	REVAC12090	REVAC14090	REVAC16090	REVAC17090	-				
	NICCHIA SOLO ZEPHYROS									
		70	REVNA12070	REVNA14070	REVNA16070	REVNA17070	-			
		75	-	REVNA14075	REVNA16075	REVNA17075	REVNA18075			
80		REVNA12080	REVNA14080	REVNA16080	REVNA17080	REVNA18080				
90		REVNA12090	REVNA14090	REVNA16090	REVNA17090	-				
70		REVNB12070	REVNB14070	REVNB16070	REVNB17070	-				
	75	-	REVNB14075	REVNB16075	REVNB17075	REVNB18075				
	80	REVNB12080	REVNB14080	REVNB16080	REVNB17080	REVNB18080				
	90	REVNB12090	REVNB14090	REVNB16090	REVNB17090	-				
	CENTRO PARETE SOLO ZEPHYROS									
		70, 75, 80, 90 cm	REVFA12080	REVFA14080	REVFA16080	REVFA17080	-			
REVFB12080			REVFB14080	REVFB16080	REVFB17080	-				
	70, 75, 80, 90 cm	REVFB12080	REVFB14080	REVFB16080	REVFB17080	-				

4 ACCESSORI



COLONNA DOCCIA BASE

per disegni e dettagli tecnici vedi pag. 357

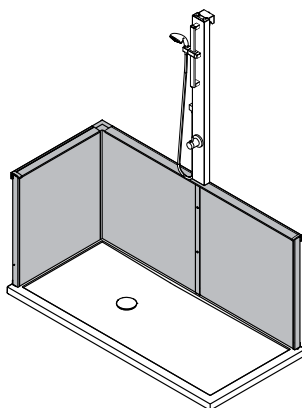

ATTACCO A MURO

	Codice	
Meccanico	REV2CM-K	
Termostatico	REV2CT-K	

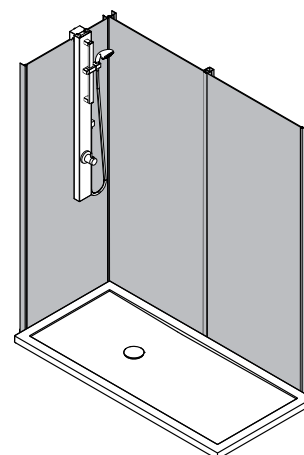

ATTACCO SU PANNELLO

	Codice	
Meccanico	REV2AM-K	
Termostatico	REV2AT-K	



COLONNA DOCCIA PLUS CON PORTAOGGETTI

per disegni e dettagli tecnici vedi pag. 356

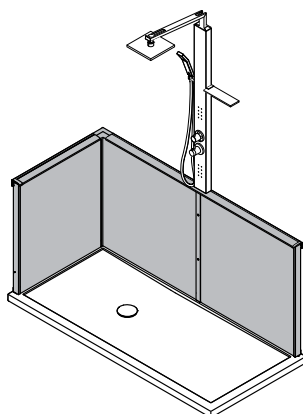

ATTACCO A MURO

	Codice	
Meccanico	REV2CVM-K	
Termostatico	REV2CVT-K	

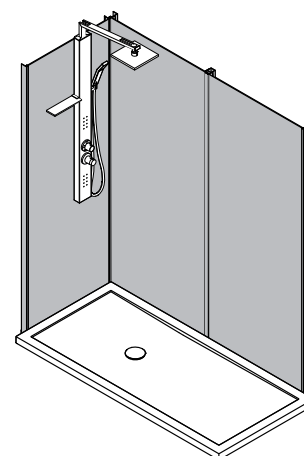

ATTACCO SU PANNELLO

	Codice	
Meccanico	REV2AVM-K	
Termostatico	REV2AVT-K	

4 ACCESSORI



SPECCHIO CON PORTAOGGETTI

Installabile a muro o su pannelli h 195 cm

Codice

REVO01

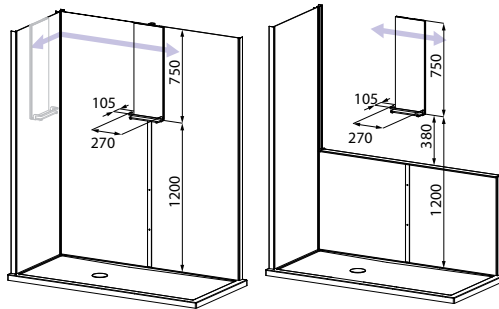

PANNELLO DI TAMPONAMENTO

Sagomabile su misura (5-25 cm) h 207,5 cm

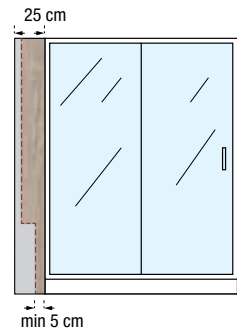

Finitura	Codice
Bianco	REVO07A
Bianco rigato	REVO07I
Burlington	REVO07N
Grain	REVO07M
Wenge	REVO07V



SEDILE RECLINABILE

IN MATERIALE EVA
impermeabile,
antibatterico e atossico
Portata indicativa 150 kg

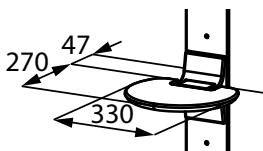

Colore	Codice
Bianco	REVO03-A
Nero	REVO03-H



POGGIAPIEDI

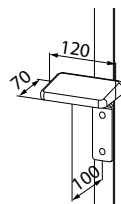

Colore	Codice
Bianco	REVO02-A
Nero	REVO02-H

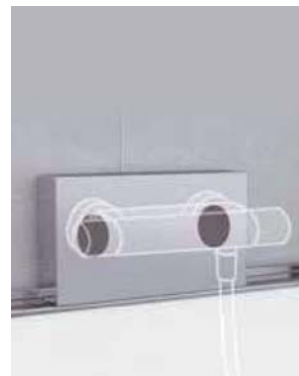

SCATOLA PER ALLACCI IDRAULICI

Completa di niples
(flessibili non compresi)

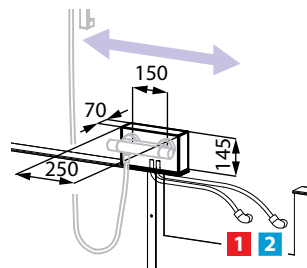

Codice
REVO04-K

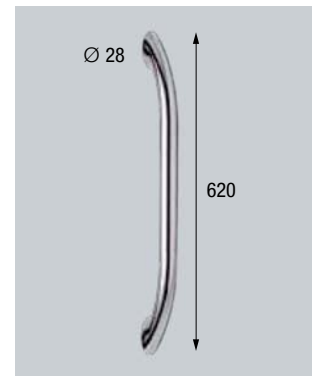

MANIGLIONE

Codice
R90MANGL0C-K

MODULO D'ORDINE

COME PERSONALIZZARE LA TUA REVOLUTION 2 IN 5 MOSSE



1 **COMPLEMENTI D'ARREDO**
p. 471

COD.

2 **PIATTO DOCCIA**
p. 472

COD.

3 **BOX DOCCIA**
p. 472

ZEPHYROS 2P

COD.

ZEPHYROS S

COD.

ZEPHYROS F

COD.

4 **PANNELLI A MURO**
p. 473

COD.

COLONNA

COD.

SEDILE

COD.

SPECCHIO

COD.

5 **ACCESSORI**
p. 473

POGGIAPIEDI

COD.

MANIGLIONE

COD.

SCATOLA PER
ALLACCI IDRAULICI

COD.

REVOLUTION 2 CON COLONNA MULTIFUNZIONE

1 COMPLEMENTI D'ARREDO COLONNA MULTIFUNZIONE



INSTALLAZIONE AD ANGOLO

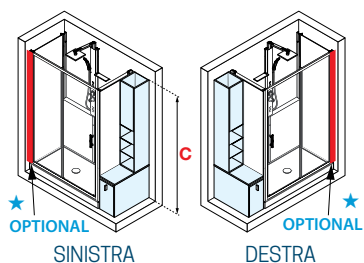

INSTALLAZIONE A CENTRO PARETE

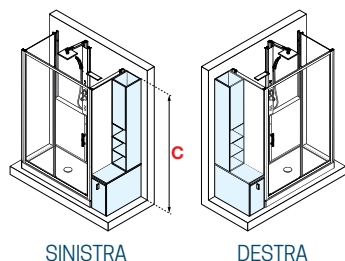

- ANTE CON SOFT CLOSING
- RIPIANI INTERNI IN VETRO (5 MM)
- PORTABIANCHERIA INCLUSO

FINITURA LACCATO



Bianco lucido

FINITURA LEGNO

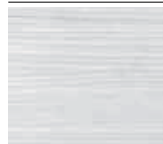

Bianco rigato

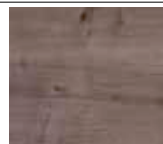

Burlington



Grain

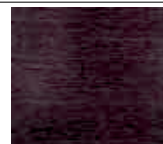

Wenge

	Misure			Codice	Scelta finitura					Prezzo
	Larghezza	Altezza	Profondità		A	I	N	M	V	
					Bianco lucido	Bianco rigato	Burlington	Grain	Wenge	
Versione sinistra	32	207,5	70	REVC08						
	32	207,5	75	REVC09						
	32	207,5	80	REVC10						
Versione destra	32	207,5	70	REVC05						
	32	207,5	75	REVC06						
	32	207,5	80	REVC07						

Disegni tecnici per l'installazione vedi pag. 519

★ **OPTIONAL PANNELLO DI TAMPONAMENTO** (5-25 cm) sagomabile (solo per installazione ad angolo)

	A	I	N	M	V	
						REVC06

REVOLUTION 2 CON COLONNA MULTIFUNZIONE

2 PIATTO DOCCIA - OLYMPIC PLUS

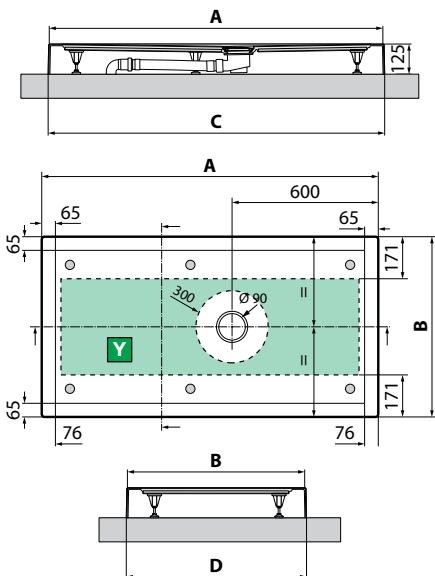

SPESSORE 12,5 CM

con antiscivolo

Misure			Codice	Scelta finitura / Prezzo						Codice	Prezzo
				30	79	11	27	29	28		30
AxB*	CxD**			Bianco	Bianco morbido	Beige	Corda	Grigio	Nero		Bianco
± 2 mm	± 3 mm										
120 x 70	1194 x 692	1200 x 698	OL1207011-							OL1207011A-	
120 x 80	1194 x 792	1200 x 798	OL8012011-							OL8012011A-	
140 x 70	1392 x 692	1398 x 698	OL1407011-							OL1407011A-	
140 x 75	1392 x 742	1398 x 748	OL1407511-							OL1407511A-	
140 x 80	1392 x 792	1398 x 798	OL1408011-							OL1408011A-	

* Misure della parte superiore del piatto
 ** Misure del piatto a pavimento

Y Zona disponibile per lo scarico sopra pavimento

3 BOX DOCCIA

Disegni tecnici per l'installazione vedi p. 516

PORTE

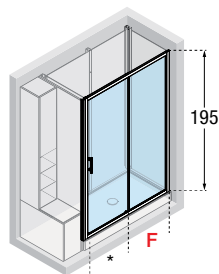

ZEPHYROS 2P Installabile in ad angolo o a centro parete con fisso laterale

Misure				Codice	Scelta vetro				Scelta Profilo /Prezzo			
Profondità piatto	Estensibilità	Fisso	Entrata		1	68	11	54	A	B	K	H
		F	*		Trasparente	Serigrafia Zephyros 1	Niva	Fumè	Bianco	Silver	Cromo	Nero opaco
120	116↔122	55	47	ZEPHYR2P116-								

Reversibile

PER INSTALLAZIONE A CENTRO PARETE

Disegni tecnici per l'installazione vedi pag. 479

1 PANNELLO FISSO

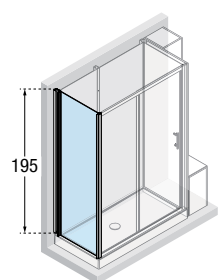

ZEPHYROS F

Misure		Codice	Scelta vetro				Scelta Profilo /Prezzo			
Profondità piatto	Estensibilità		1	68	11	54	A	B	K	H
			Trasparente	Serigrafia Zephyros 1	Niva	Fumè	Bianco	Silver	Cromo	Nero opaco
70	68↔71	ZEPHYRF68-								
75	73↔76	ZEPHYRF73-								
80	78↔81	ZEPHYRF78-								

Reversibile

REVOLUTION 2 CON COLONNA MULTIFUNZIONE

4 PANNELLI A MURO

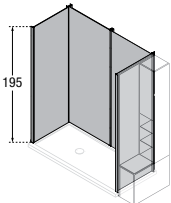
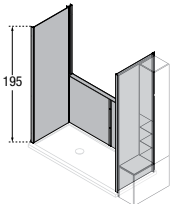
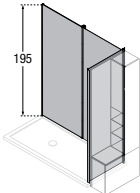
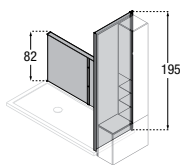
ANGOLO	Profondità	Larghezza / codice		Bianco	Nero	Prezzo
		120 cm	140 cm	-A	-H	
	70	REVNA12070	REVNA14070			
	75	-	REVNA14075			
	80	REVNA12080	REVNA14080			
	70	REVNB12070	REVNB14070			
	75	-	REVNB14075			
	80	REVNB12080	REVNB14080			
CENTRO PARETE SOLO ZEPHYROS		120 cm	140 cm	-A	-H	
	70	REVAA12070	REVAA14070			
	75	-	REVAA14075			
	80	REVAA12080	REVAA14080			
	70	REVAB12070	REVAB14070			
	75	-	REVAB14075			
	80	REVAB12080	REVAB14080			

5 ACCESSORI

 <p>COLONNA DOCCIA BASE</p> <p>ATTACCO A MURO Meccanico REV2CM-K Termostatico REV2CT-K</p> <p>ATTACCO SU PANNELLO Meccanico REV2AM-K Termostatico REV2AT-K</p>	 <p>COLONNA DOCCIA PLUS CON PORTAOGGETTI</p> <p>ATTACCO A MURO Meccanico REV2CVM-K Termostatico REV2CVT-K</p> <p>ATTACCO A PANNELLO Meccanico REV2AVM-K Termostatico REV2AVT-K</p>	 <p>SPECCHIO CON PORTAOGGETTI</p> <p>REV001</p>	
 <p>SEDILE RECLINABILE</p> <p>Bianco REV003-A Nero REV003-H</p>	 <p>SCATOLA PER ALLACCI IDRAULICI</p> <p>REV004-K</p>	 <p>POGGIAPIEDI</p> <p>Bianco REV002-A Nero REV002-H</p>	 <p>MANIGLIONE</p> <p>Cromo R90MANGLOC-K</p>

REVOLUTION 2 CON PORTALAVATRICE

1 COMPLEMENTI D'ARREDO PORTALAVATRICE CON CASSETTIERE

SINISTRA

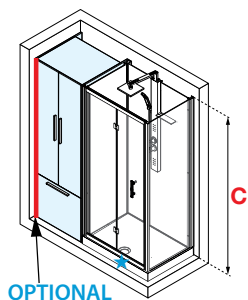

OPTIONAL

DESTRA

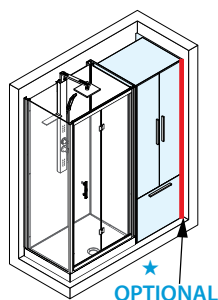

OPTIONAL

- ANTE CON SOFT CLOSING
- VASCHETTA RACCOGLI ACQUA CON SCARICO ESTERNO



FINITURA LACCATO



Bianco lucido

FINITURA LEGNO



Bianco rigato

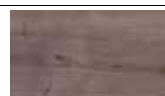

Burlington

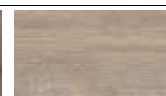

Grain



Wenge

Misure			Codice	Scelta finitura					Prezzo
Larghezza	Altezza	Profondità		A	I	N	M	V	
				Bianco lucido	Bianco rigato	Burlington	Grain	Wenge	

VERSIONE ABBINATA A BOX DOCCIA

72	206,5	70	REVC01					
72	206,5	80	REVC02					

VERSIONE SOLO MOBILE

72	206,5	70	REVCS1					
72	206,5	80	REVCS2					

Disegni tecnici per l'installazione vedi pag. 479

★ OPTIONAL PANNELLO DI TAMPONAMENTO (5-25 cm) sagomabile (solo per installazione ad angolo)

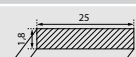
			A	I	N	M	V
	max 25- h 206,5	REVO06					

OPTIONAL

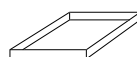

VASSOIO PORTA DETERSIVI

200 x 460 x H 30

Codice

REVB11A

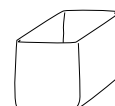

PORTA BIANCHERIA

360 x 460 x H 360

Codice

REVB11B



VERSIONE SOLO MOBILE

REVOLUTION 2 CON PORTALAVATRICE+ASCIUGATRICE

1 COMPLEMENTI D'ARREDO PORTALAVATRICE + ASCIUGATRICE

SINISTRA

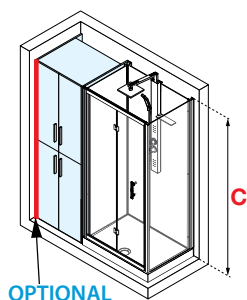

OPTIONAL

DESTRA

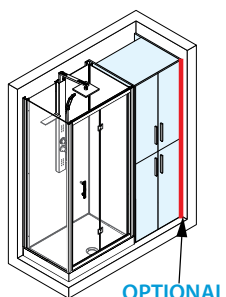

OPTIONAL

- ANTE CON SOFT CLOSING
- VASCHETTA RACCOGLI ACQUA CON SCARICO ESTERNO



FINITURA LACCATO

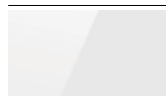

Bianco lucido

FINITURA LEGNO



Bianco rigato

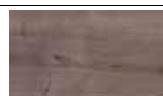

Burlington



Grain



Wenge



VERSIONE SOLO MOBILE

Misure			Codice	Scelta finitura					Prezzo
Larghezza	Altezza	Profondità		A	I	N	M	V	
		C		Bianco lucido	Bianco rigato	Burlington	Grain	Wenge	

VERSIONE ABBINATA A BOX DOCCIA

72	206,5	70	REVC03					
72	206,5	80	REVC04					

VERSIONE SOLO MOBILE

72	206,5	70	REVCS3					
72	206,5	80	REVCS4					

Disegni tecnici per l'installazione vedi pag. 479

★ **OPTIONAL PANNELLO DI TAMPONAMENTO** (5-25 cm) sagomabile (solo per installazione ad angolo)

	A	I	N	M	V	
max 25- h 206,5	REV006					

REVOLUTION 2 CON PORTALAVATRICE

2 PIATTO DOCCIA - OLYMPIC

SPESSORE 11,5 CM

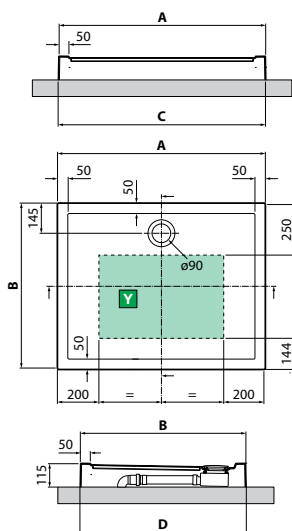

Misure		Codice	Scelta finitura / Prezzo					
			30	79	11	27	29	28
			Bianco	Bianco morbido	Beige	Corda	Grigio	Nero
	AxB * ± 2 mm	CxD ** ± 3 mm						
90 x 70	894 x 694	896 x 696	OLN907011-					
100 x 70	994 x 694	996 x 696	OLN1007011-					
100 x 80	994 x 794	996 x 796	OLN1008011-					
120 x 80	1194 x 794	1196 x 796	OLN1208011-					

* Misure della parte superiore del piatto
** Misure del piatto a pavimento

Y Zona disponibile per lo scarico sopra pavimento

OPTIONAL

PILETTA DI SCARICO
Ø 90

8 cm

Codice

PIL90PCAB-CR40

3 BOX DOCCIA

Disegni tecnici per l'installazione vedi p. 479

PORTE

ZEPHYROS S REVERSIBILE

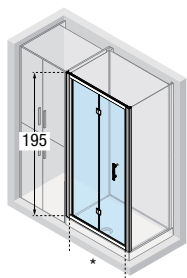

Misure		Codice	Scelta vetro				Scelta Profilo / Prezzo			
Larghezza piatto	Estensibilità	Fisso Entrata	1	68	11	54	A	B	K	H
		B *	Trasparente	Serigrafia Zephyros 1	Niva	Fumè	Bianco	Silver	Cromo	Nero opaco
90	86↔92	41 67								
100	96↔102	46 77								

ZEPHYROS 2P REVERSIBILE

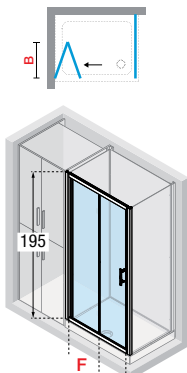

Misure		Codice	Scelta vetro				Scelta Profilo / Prezzo			
Profondità piatto	Estensibilità	Fisso Entrata	1	68	11	54	A	B	K	H
		F *	Trasparente	Serigrafia Zephyros 1	Niva	Fumè	Bianco	Silver	Cromo	Nero opaco
120	116↔122	55 47								

1 PANNELLO FISSO

ZEPHYROS F REVERSIBILE

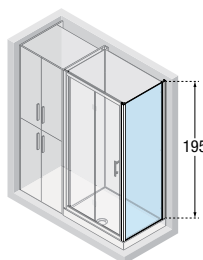

Misure		Codice	Scelta vetro				Scelta Profilo / Prezzo			
Profondità piatto	Estensibilità		1	68	11	54	A	B	K	H
			Trasparente	Serigrafia Zephyros 1	Niva	Fumè	Bianco	Silver	Cromo	Nero opaco
70	68↔71	ZEPHYRF68-								
80	78↔81	ZEPHYRF78-								

REVOLUTION 2 CON PORTALAVATRICE

4 PANNELLI A MURO

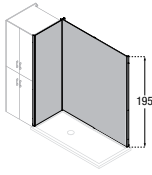
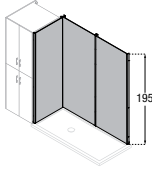
	Profondità	Larghezza / codice			Bianco	Nero	Prezzo
		90 cm	100 cm	120 cm	-A	-H	
ANGOLO							
	70	REVAA9070	REVAA10070	-			
	80	-	REVAA10080	-			
	80	-	-	REVAA12080			

5 ACCESSORI

	COLONNA DOCCIA BASE		COLONNA DOCCIA PLUS CON PORTAOGGETTI		SPECCHIO CON PORTAOGGETTI
ATTACCO A MURO	ATTACCO SU PANNELLO	ATTACCO A MURO	ATTACCO A PANNELLO		
Meccanico REV2CM-K Termostatico REV2CT-K	Meccanico REV2AM-K Termostatico REV2AT-K	Meccanico REV2CVM-K Termostatico REV2CVT-K	Meccanico REV2AVM-K Termostatico REV2AVT-K		REV001
					MANIGLIONE

INSTALLABILI SOLO PER LA MISURA 120x80

	SEDILE RECLINABILE		POGGIAPIEDI		Cromo R90MANGL0C-K
Bianco REV003-A Nero REV003-H		Bianco REV002-A Nero REV002-H			

OPTIONAL

PANNELLO DI TAMPONAMENTO (5-25 cm) H 206,5 cm (sagomabile su misura)

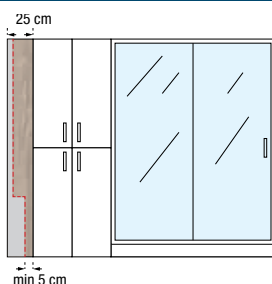

Finitura	Codice
Bianco	REV006A
Bianco rigato	REV006I
Burlington	REV006N
Grain	REV006M
Wenge	REV006V

Il pannello di tamponamento è sagomabile e consente l'installazione di Revolution anche in presenza di ostacoli in muratura o di impiantistica sulla parete.

La misura minima dopo la sagomatura è di 50 mm.

INSTALLAZIONE IN NICCHIA SOLO PER ZEPHYROS

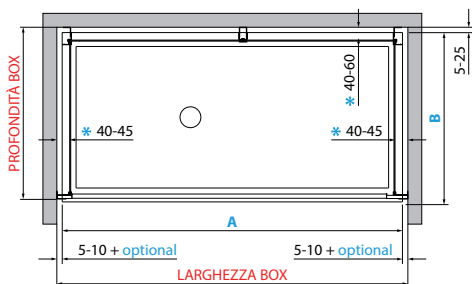

piatto	LARGHEZZA BOX			
A	STANDARD estensibilità	optional		
		per Zephyros	per Giada	PANNELLO di TAMPONAMENTO sagomabile su misura (50-250)
120	1205-1220	max 1245	max 1260	max 1275
140	1405-1420	max 1445	max 1460	max 1475
160	1605-1620	max 1645	max 1660	max 1675
170	1705-1720	max 1745	max 1760	max 1775
180	1805-1820	max 1845	max 1860	max 1875

piatto	PROFONDITÀ BOX	
B	STANDARD estensibilità	
	70	685-705
	75	735-755
	80	785-805
	90	885-905

INSTALLAZIONE CENTRO PARETE SOLO PER ZEPHYROS

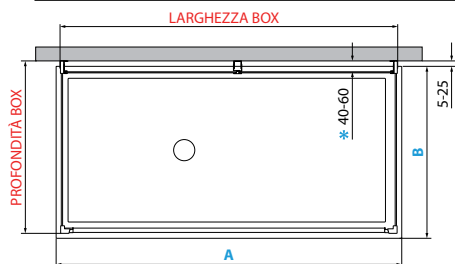

piatto	LARGHEZZA BOX
A	
120	1175
140	1375
160	1575
170	1675
180	1775

piatto	PROFONDITÀ BOX
B	
70	685-705
75	735-755
80	785-805



ATTENZIONE!
Spazio disponibile per allacci idraulici

INSTALLAZIONE AD ANGOLO PER ZEPHYROS E GIADA

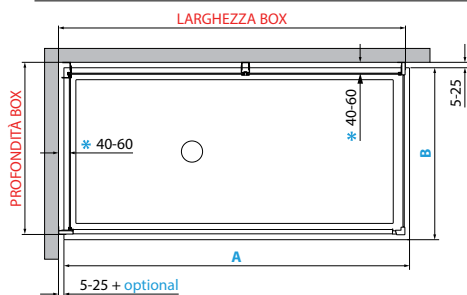

piatto	LARGHEZZA BOX		
A	STANDARD estensibilità	optional non possibile con pannelli a muro tutti bassi	
		per Zephyros	per Giada
120	1190-1210	max 1225	max 1460
140	1390-1410	max 1425	max 1660
160	1590-1610	max 1625	max 1860
170	1690-1710	max 1725	max 1960
180	1790-1810	max 1825	max 2060

piatto	PROFONDITÀ BOX	
B	STANDARD estensibilità	
	70	685-705
	75	735-755
	80	785-805
	90	885-905

INSTALLAZIONE AD ANGOLO PER PORTALAVATRICE / ASCIUGATRICE

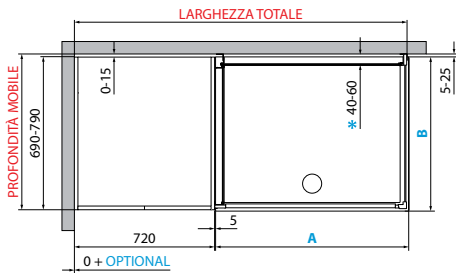

piatto	LARGHEZZA TOTALE	
A	STANDARD	optional (50-250 mm) PANNELLO DI TAMPONAMENTO sagomabile su misura
90	1610	max 1860
100	1710	max 1960
120	1910	max 2160

piatto	PROFONDITÀ MOBILE
B	
70	690-705
80	790-805

INSTALLAZIONE AD ANGOLO PER COLONNA MULTIFUNZIONE

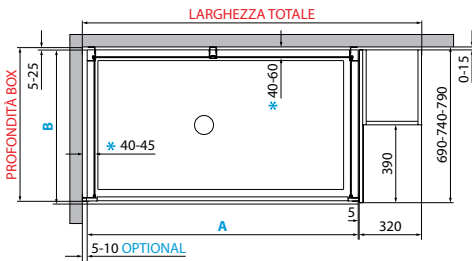

piatto	LARGHEZZA TOTALE	
A	STANDARD	optional (50-250 mm) PANNELLO DI TAMPONAMENTO sagomabile su misura
120	1525-1530	max 1780
140	1725-1730	max 1980

piatto	PROFONDITÀ BOX
B	
70	685-705
75	735-755
80	785-805

INSTALLAZIONE CENTRO PARETE PER COLONNA MULTIFUNZIONE

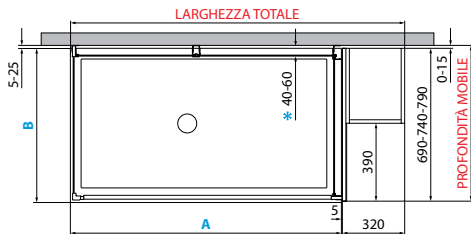

piatto	LARGHEZZA TOTALE
A	
120	1510
140	1710

piatto	PROFONDITÀ MOBILE
B	
70	690-705
75	740-755
80	790-805

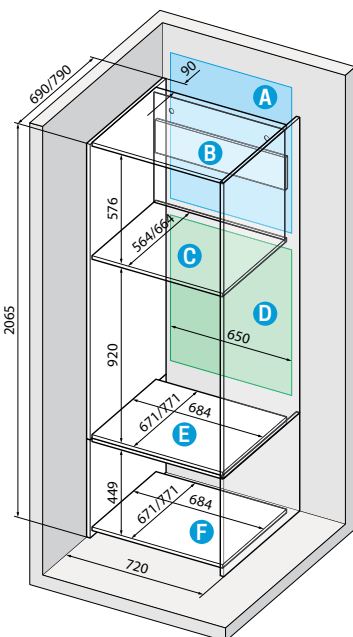

MOBILE PORTALAVATRICE CON CASSETTIERE

- A** Area allacci elettrici
- B** Vano con parete smontabile
- C** Piano appoggio biancheria
- D** Vano senza pareti posteriori per lo scarico e allacci idraulici
- E** Piano appoggio lavatrice
- F** Piano cassetto estraibile

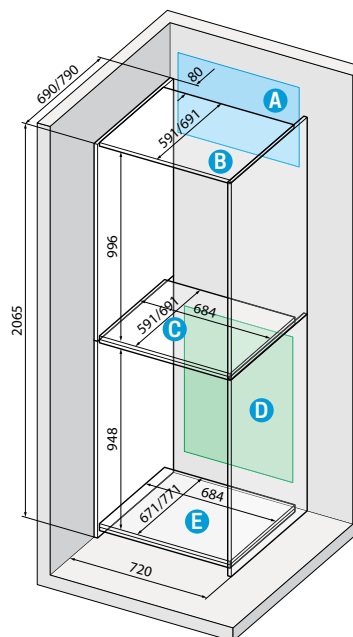

MOBILE PORTALAVATRICE + ASCIUGATRICE

- A** Area allacci elettrici
- B** Vano senza pareti posteriori
- C** Piano appoggio asciugatrice
- D** Vano senza pareti posteriori per lo scarico e allacci idraulici
- E** Piano appoggio lavatrice