

SKILL 2P



CABINA MULTIFUNZIONE ASIMMETRICA, APERTURA 1 ANTA SCORREVOLE E 1 FISSA IN LINEA CON 1 FISSO LATERALE
 Design Marco Pellici

Misure				Codice	Installazione		Miscelatore		Vetro	Scelta finitura											
Dimensioni	Piatto doccia (cm)	Altezza totale (cm)	Entrata (cm)		D	S	M	T		Finitura bianco lucido				Finitura bianco morbido							
										AN0	AN1	AN2	AN3	UN0	UN1	UN2	UN3	UU			
									1												

ESSENTIAL



					D	S	M1F-	T1F-	1	AN0	AN1	AN2	AN3	UN0	UN1	UN2	UN3	UU
140x80	H 4,5	209,5	55	SKI2P140														
140x80	H 12,5	217,5	55	SKI2P149														

HAMMAM



					D	S	M5-	T5-	1	AN0	AN1	AN2	AN3	UN0	UN1	UN2	UN3	UU
140x80	H 4,5	209,5	55	SKI2P140														
140x80	H 12,5	217,5	55	SKI2P149														





SKILL 2P PERLA

SKILL

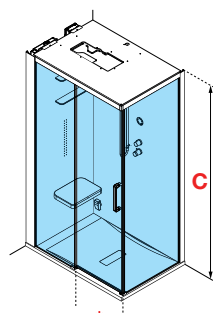

S Sinistra

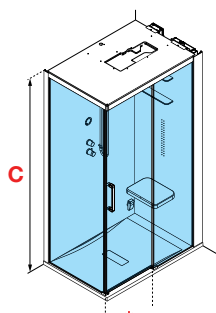

D Destra

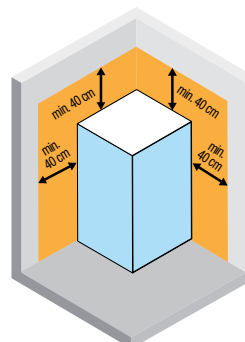

**GARANTIRE IL RICAMBIO
D'ARIA E LO SPAZIO
PER LA MANUTENZIONE
DELLA SAUNA
(VEDI MANUALE DI
INSTALLAZIONE)**

SKILL PIATTO 45 MM

DISEGNI TECNICI

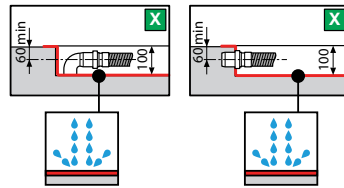
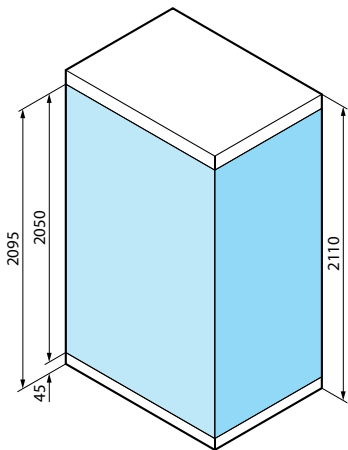

versione **sinistra**

versione **destra**

per modelli **A100x80 - A120x80 - A120x90 - A120x100 - 2P 140x80**

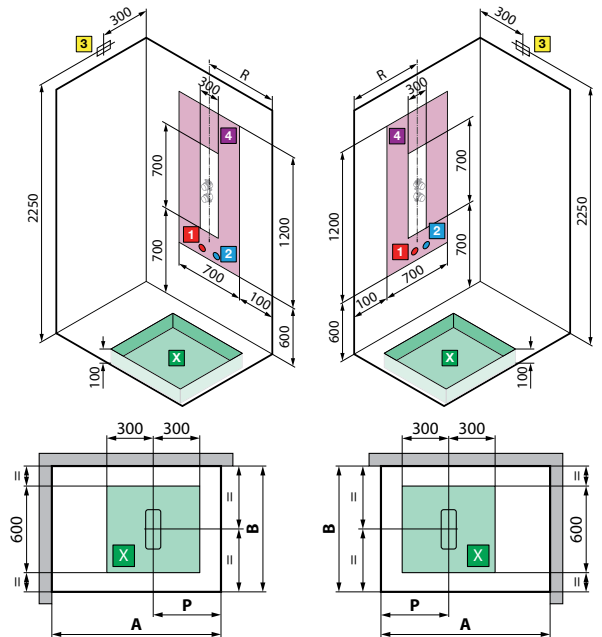

modello	A ± 2	B ± 2	P	R
A100x80	1000	800	400	450
A120x80	1200	800	500	550
A120x90	1200	900	500	550
A120x100	1200	1000	500	550
2P140x80	1400	800	600	650

SKILL PIATTO 125 MM

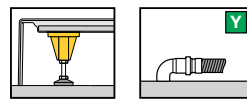
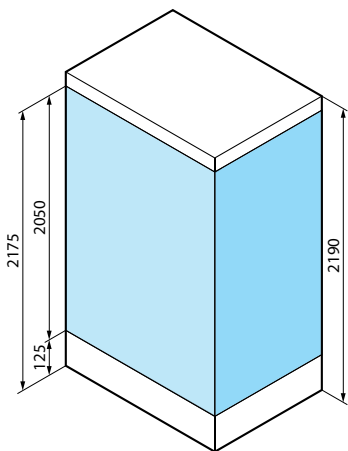

versione **sinistra**

versione **destra**

per modelli **A100x80 - A120x80 - A120x90 - A120x100 - 2P 140x80**

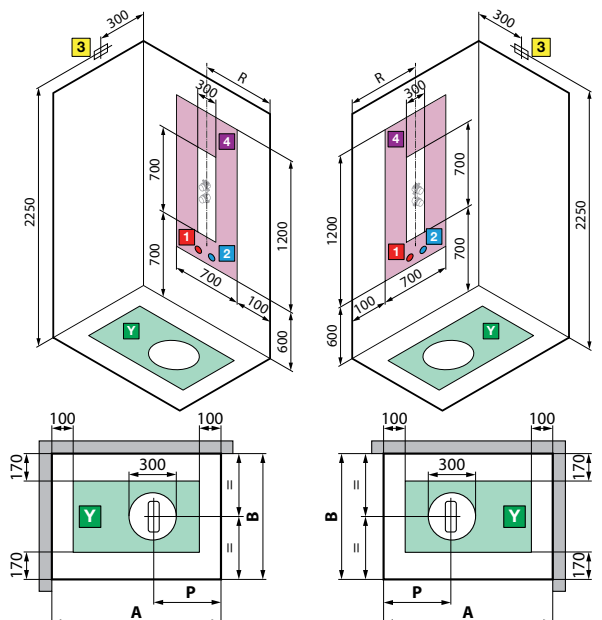

modello	A ± 2	B ± 2	P	R
A100x80	1000	800	400	450
A120x80	1200	800	500	550
A120x90	1200	900	500	550
A120x100	1200	1000	500	550
2P140x80	1400	800	600	650

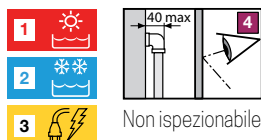

EN55014-1
EN55014-2
Il prodotto è certificato in accordo alle normative di compatibilità elettromagnetica

ATTENZIONE!
Può essere dannoso ai portatori di pacemakers

CARATTERISTICHE IDRAULICHE:
Pressione dinamica ottimale 2-5 bar
Acqua calda 1/2"
Acqua fredda 1/2"
Allaccio sifone con raccordo ø 40 mm

CARATTERISTICHE ELETTRICHE:
Tensione 220 - 230 V
Frequenza 50/60 Hz
Potenza massima assorbita: 2600 W
Potenza nominale: 2500 W

ATTENZIONE! Installare a monte dell'apparecchio un interruttore differenziale da 30mA provvisto di interruttore onnipolare con apertura minima dei contatti ≥ 3 mm.

SKILLA



CABINA MULTIFUNZIONE ASIMMETRICA, APERTURA 2 ANTE SCORREVOLI E 2 FISSE

Design Marco Pellici

Misure				Codice	Installa- zione		Miscelatore		Vetro	Scelta finitura									
										Finitura bianco lucido				Finitura bianco morbido					
Dimensioni	Piatto doccia (cm)	Altezza totale (cm)	Entrata (cm)		D	S	M	T	1	AN0	AN1	AN2	AN3	UN0	UN1	UN2	UN3	UU	

C

*

Destra Sinistra Meccanico Termostatico Trasparente

Blu brillante

Grigio chiaro

Tortora

Perla

Blu brillante

Grigio chiaro

Tortora

Perla

Bianco morbido

ESSENTIAL



					D	S	M1F-	T1F-	1	AN0	AN1	AN2	AN3	UN0	UN1	UN2	UN3	UU
100x80	H 4,5	209,5	44	SKIA100														
100x80	H 12,5	217,5	44	SKIA109														
120x80	H 4,5	209,5	51	SKIA120														
120x80	H 12,5	217,5	51	SKIA129														
120x90	H 4,5	209,5	54	SKIA290														
120x90	H 12,5	217,5	54	SKIA299														
120x100	H 4,5	209,5	58	SKIA210														
120x100	H 12,5	217,5	58	SKIA219														

HAMMAM



					D	S	M5-	T5-	1	AN0	AN1	AN2	AN3	UN0	UN1	UN2	UN3	UU
100x80	H 4,5	211	44	SKIA100														
100x80	H 12,5	219	44	SKIA109														
120x80	H 4,5	211	51	SKIA120														
120x80	H 12,5	219	51	SKIA129														
120x90	H 4,5	211	54	SKIA290														
120x90	H 12,5	219	54	SKIA299														
120x100	H 4,5	211	58	SKIA210														
120x100	H 12,5	219	58	SKIA219														





SKILL

SKILL A PERLA

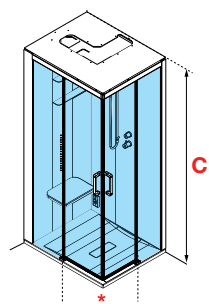

S Sinistra

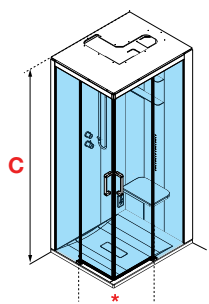

D Destra

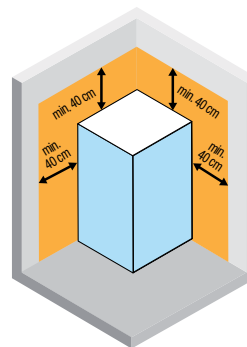

**GARANTIRE IL RICAMBIO
D'ARIA E LO SPAZIO
PER LA MANUTENZIONE
DELLA SAUNA
(VEDI MANUALE DI
INSTALLAZIONE)**

SKILL PIATTO 45 MM

DISEGNI TECNICI

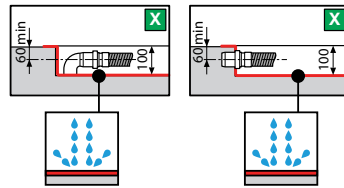
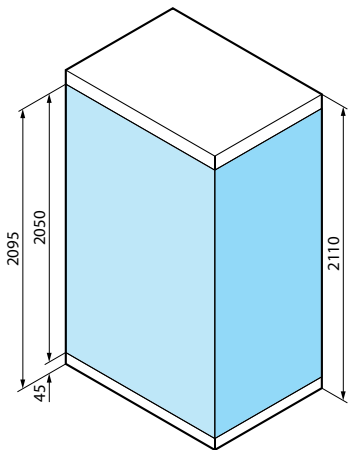

versione **sinistra**

versione **destra**

per modelli **A100x80 - A120x80 - A120x90 - A120x100 - 2P 140x80**

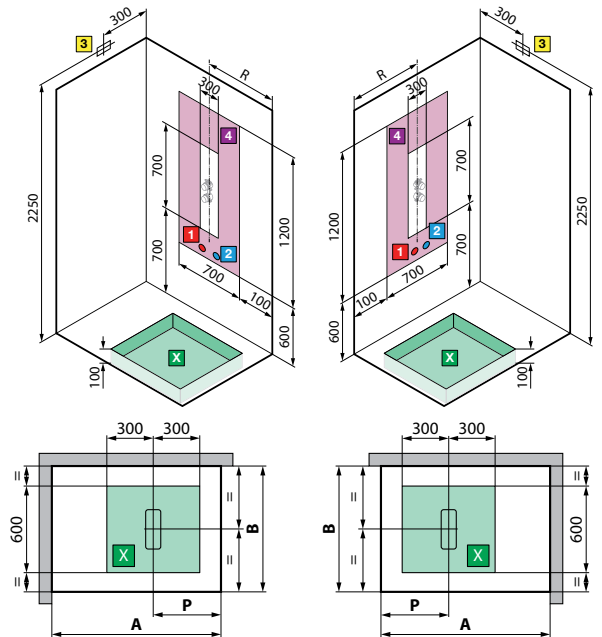

modello	A ± 2	B ± 2	P	R
A100x80	1000	800	400	450
A120x80	1200	800	500	550
A120x90	1200	900	500	550
A120x100	1200	1000	500	550
2P140x80	1400	800	600	650

SKILL PIATTO 125 MM

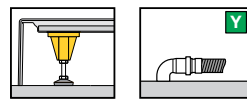
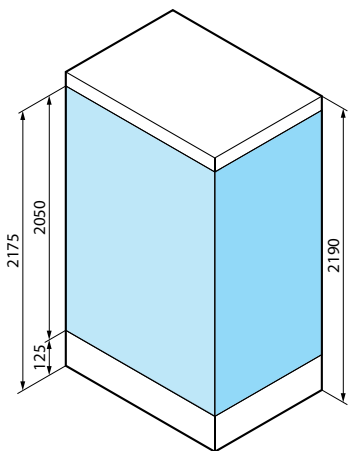

versione **sinistra**

versione **destra**

per modelli **A100x80 - A120x80 - A120x90 - A120x100 - 2P 140x80**

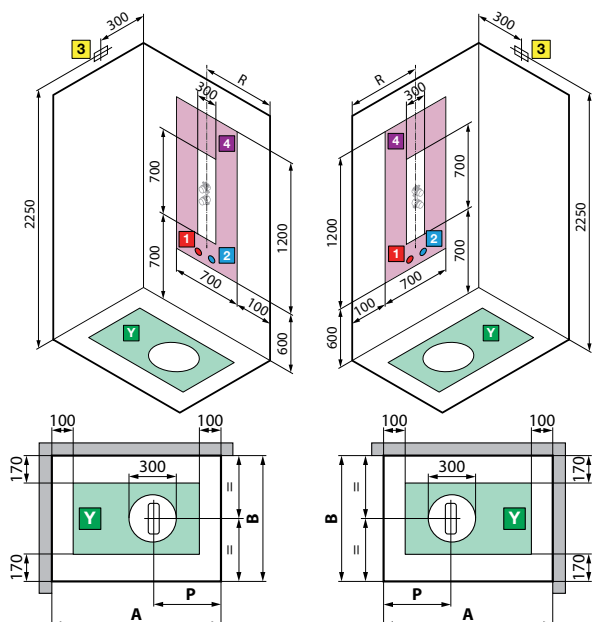

modello	A ± 2	B ± 2	P	R
A100x80	1000	800	400	450
A120x80	1200	800	500	550
A120x90	1200	900	500	550
A120x100	1200	1000	500	550
2P140x80	1400	800	600	650

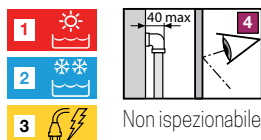

EN55014-1
EN55014-2
Il prodotto è certificato in accordo alle normative di compatibilità elettromagnetica

ATTENZIONE!
Può essere dannoso ai portatori di pacemakers

CARATTERISTICHE IDRAULICHE:
Pressione dinamica ottimale 2-5 bar
Acqua calda 1/2"
Acqua fredda 1/2"
Allaccio sifone con raccordo ø 40 mm

CARATTERISTICHE ELETTRICHE:
Tensione 220 - 230 V
Frequenza 50/60 Hz
Potenza massima assorbita: 2600 W
Potenza nominale: 2500 W

ATTENZIONE! Installare a monte dell'apparecchio un interruttore differenziale da 30mA provvisto di interruttore onnipolare con apertura minima dei contatti ≥ 3 mm.

SKILL DUAL



CABINA MULTIFUNZIONE: DOPPIA POSTAZIONE E SAUNA DI VAPORE, APERTURA 2 ANTE SCORREVOLI E 2 FISSE IN LINEA

Design Marco Pellici

Misure				Codice	Installazione		Miscelatore	Vetro	Scelta finitura									
									Finitura bianco lucido					Finitura bianco opaco				
Dimensioni	Piatto doccia (cm)	Altezza totale (cm)	Entrata (cm)		D	S	T5-	1	AN0	AN1	AN2	AN3	UN0	UN1	UN2	UN3	UU	
	C		*		Destra	Sinistra	Termostatico	Trasparente	Blu brillante	Grigio chiaro	Tortora	Perla	Blu brillante	Grigio chiaro	Tortora	Perla	Bianco opaco	
HAMMAM CENTRO PARETE																		
							T5-	1	AN0	AN1	AN2	AN3	UN0	UN1	UN2	UN3	UU	
160 x 97	H 4,5	211	62	SKI2A160														
160 x 97	H 12,5	219	62	SKI2A169	-	-												
HAMMAM INSTALLAZIONE AD ANGOLO																		
					D	S	T5-	1	AN0	AN1	AN2	AN3	UN0	UN1	UN2	UN3	UU	
160 x 97	H 4,5	211	62	SKI2A160														
160 x 97	H 12,5	219	62	SKI2A169														

SKILL

Costruzione del codice **Codice** + **Installazione** + **Miscelatore** + **Vetro** + **Finitura** = Codice prodotto finale



SKILL DUAL PERLA

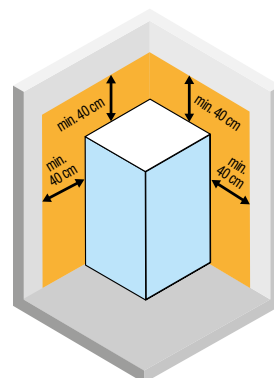
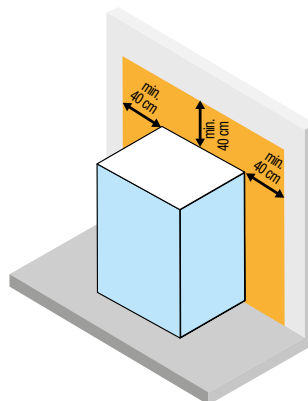
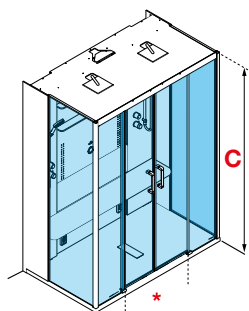
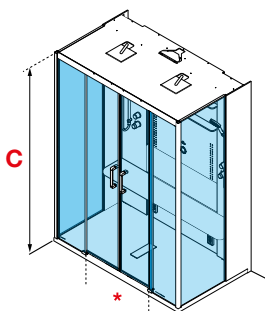

**GARANTIRE IL RICAMBIO
D'ARIA E LO SPAZIO
PER LA MANUTENZIONE
DELLA SAUNA
(VEDI MANUALE DI
INSTALLAZIONE)**

350



S Sinistra
Costruzione
del codice

D Destra
Codice + Installazione + Miscelatore + Vetro + Finitura
struttura + Finitura
fasce = Codice
prodotto finale

SKILL DUAL PIATTO 45 MM

DISEGNI TECNICI

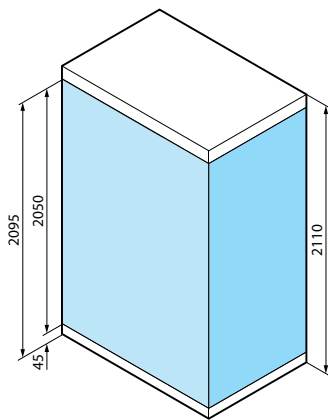

installazione a centro parete

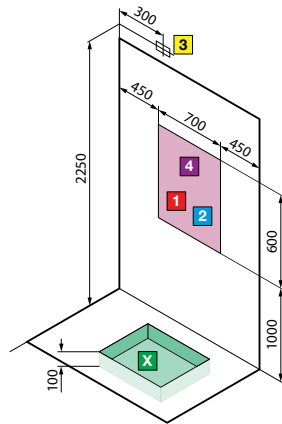

versione **sinistra**

versione **destra**

installazione ad angolo

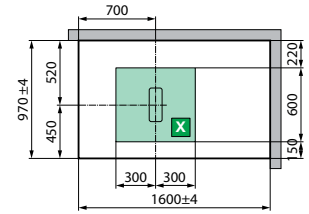
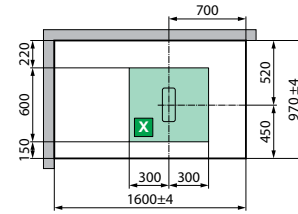
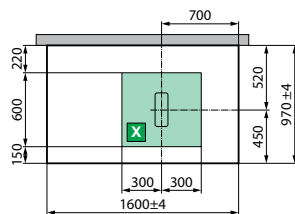
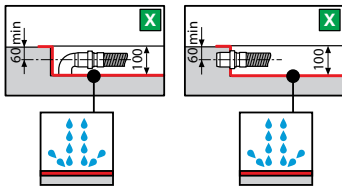
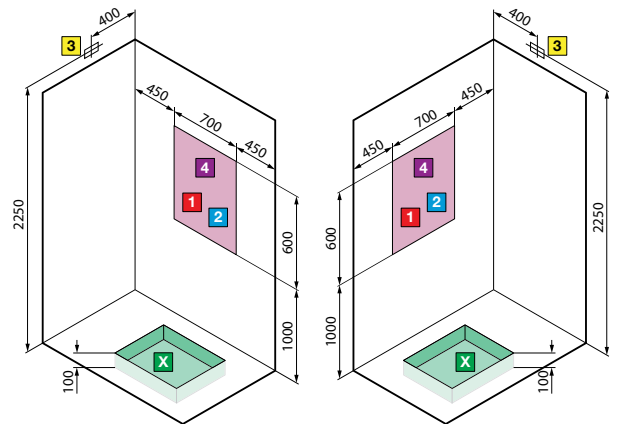

SKILL DUAL PIATTO 125 MM

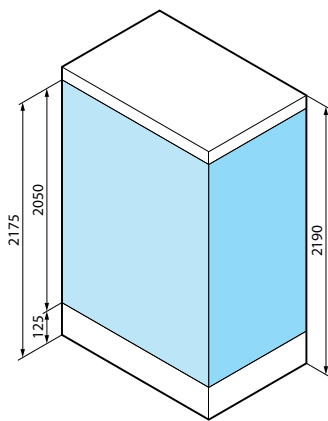

installazione a centro parete

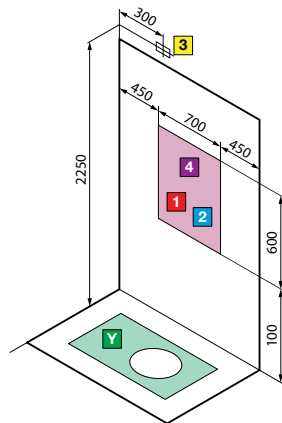

versione **sinistra**

versione **destra**

installazione ad angolo

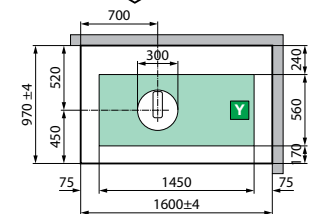
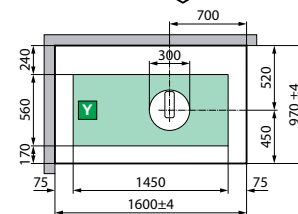
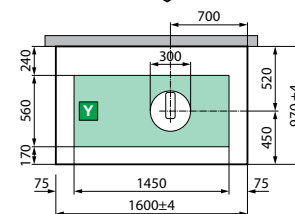
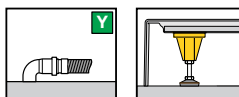
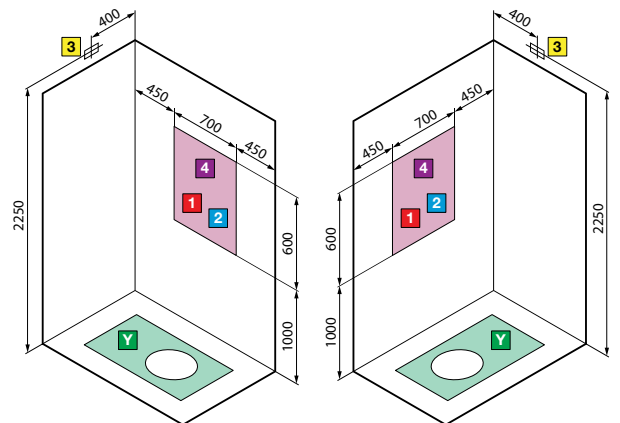

Non ispezionabile



EN55014-1
EN55014-2

Il prodotto è certificato in accordo alle normative di compatibilità elettromagnetica



ATTENZIONE!

Può essere dannoso ai portatori di pacemakers

CARATTERISTICHE IDRAULICHE:

Pressione dinamica ottimale 2÷5 bar
Acqua calda 1/2"
Acqua fredda 1/2"
Allaccio sifone con raccordo ø 40 mm

CARATTERISTICHE ELETTRICHE:

Tensione 220 - 230 V
Frequenza 50/60 Hz
Potenza massima assorbita: 5100 W
Potenza nominale: 5000 W

ATTENZIONE! Installare a monte dell'apparecchio un interruttore differenziale da 30mA provvisto di interruttore onnipolare con apertura minima dei contatti ≥ 3 mm.