

CAPSULE

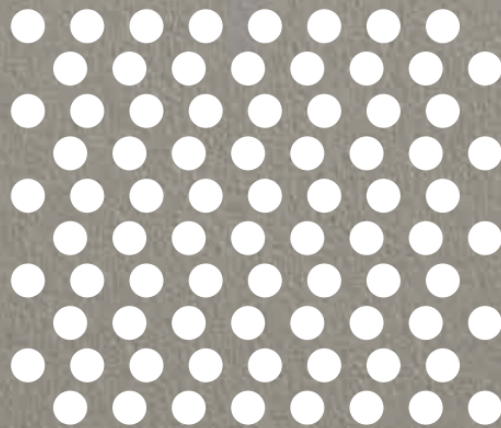
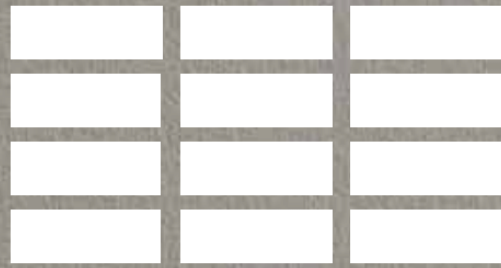

bongio[®]
MADE IN ITALY SINCE 1936

CAPSULE

DESIGN CENTER BY
BONGIO LAB



DETAILS OF STYLE

CAPSULE

GIOIELLI DI DESIGN

Design jewelry

Con Capsule il bagno si trasforma in un autentico scrigno di lusso, impreziosito da gioielli di design unici: tre nuove texture distinte che parlano il linguaggio della contemporaneità.
Frutto di maestria artigianale e tecnologia d'avanguardia, le geometrie a rilievo disegnano decori dalle forme nette e precise. Vere e proprie opere d'arte che riflettono una ricchezza straordinaria nelle numerose finiture dedicate, per la massima attenzione al dettaglio.

With Capsule, the bathroom fills up with luxury thanks to unique gems of design: three new distinctive, contemporary textures. The result of craftsmanship and cutting-edge technology, embossed geometries create decorations with clear and precise shapes. True works of art that display an extraordinary richness through the many dedicated finishes, with maximum attention to detail.



CAPSULE

Dall'evoluzione del design geometrico nasce Capsule, una collezione di maniglie ispirate all'incontro tra arte tessile e alta gioielleria.

Tre texture tridimensionali, Glow, Grain e Cannelé, personalizzano la rubinetteria di spazi residenziali e commerciali. I motivi danno vita a combinazioni sofisticate, con giochi di luce che rendono unico ogni elemento.

Capsule originates from the evolution of geometric design, a collection of handles inspired by textile art and refined jewelry coming together.

Three three-dimensional textures, Glow, Grain and Cannelé, allow for the customization of taps in residential and commercial spaces. The motifs give life to sophisticated combinations, with plays of light that make each element unique.

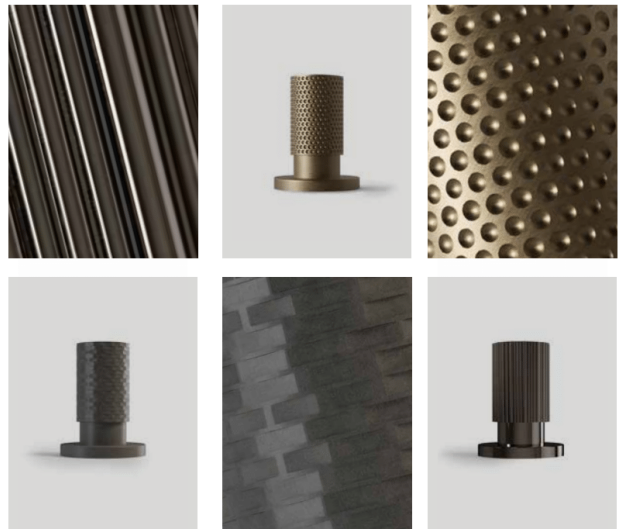

La bellezza tridimensionale in un raffinato equilibrio di stili.

Three-dimensional beauty in a refined balance of styles.

bonqo

LAVABO / WASHBASIN
 01 Art. 8840181GG
 02 Art. 88401PLCCOH
 03 Art. 8840082CC
 04 Art. 88400DFGA
 05 Art. 88400APGG



THE BEAUTY OF ANCIENT FINISHES

Rame
 anticato
 ANTIQUED
 COPPER

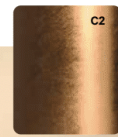

Oro
 anticato
 ANTIQUED
 GOLD

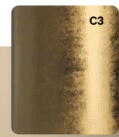

Metallo
 brunito
 ANTIQUED
 IRON

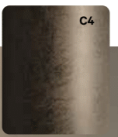

LAVABO / WASHBASIN
 01 Art. 88322C2GG
 02 Art. 88321C4GG
 03 Art. 88400C3CC
 04 Art. 88400PLGG
 05 Art. 88400ORGA



CAPSULE



bongio

**GLOW**

è un gioiello da toccare,
made in Bongio.

La trama orizzontale
di intagli sfalsati corre
sulla superficie della
manopola e veste
il bagno di rifrazioni e
sfaccettature di luce.

Bathe in the glow of luxury.

Glow is a jewel to the touch, made in Bongio. The horizontal pattern of staggered carvings runs across the knob's surface and fills the bathroom with glares and facets of light.

LAVABO / WASHBASIN
Art. 88400CNGG

CAPSULE

GRAIN

evoca la cura dell'arte sartoriale con un pattern di incisioni tonde che avvolgono le maniglie per miscelatori.

Sartorial elegance.

Grain evokes the care of sartorial art with a pattern of round engravings enveloping the mixer's handles.

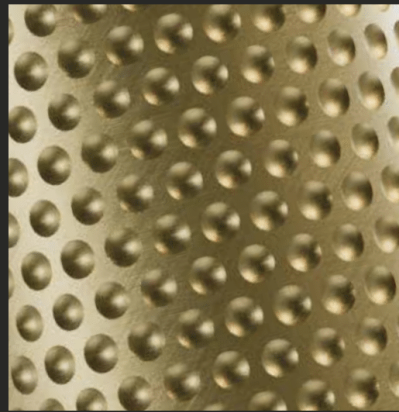

CAPSULE



bonqo



CANNETÉ

Segni rettilinei disegnano
traiettorie parallele.
Una sequenza di linee
che definisce un profilo
geometrico ed esalta
il rigore distintivo
della maniglia.

Design to touch.

Straight lines draw parallel trajectories.
A sequence that defines the geometric
profile, enhancing the distinctive rigor
of the handle.

CAPSULE

Tagli sfalsati,
netti e precisi.
Una dichiarazione
di stile per
l'interior design.

STAGGERED, CLEAN
AND PRECISE CUTS.
A STYLISH STATEMENT
OF INTERIOR DESIGN.

LAVABO / WASHBASIN
Art. 0100782GGOR

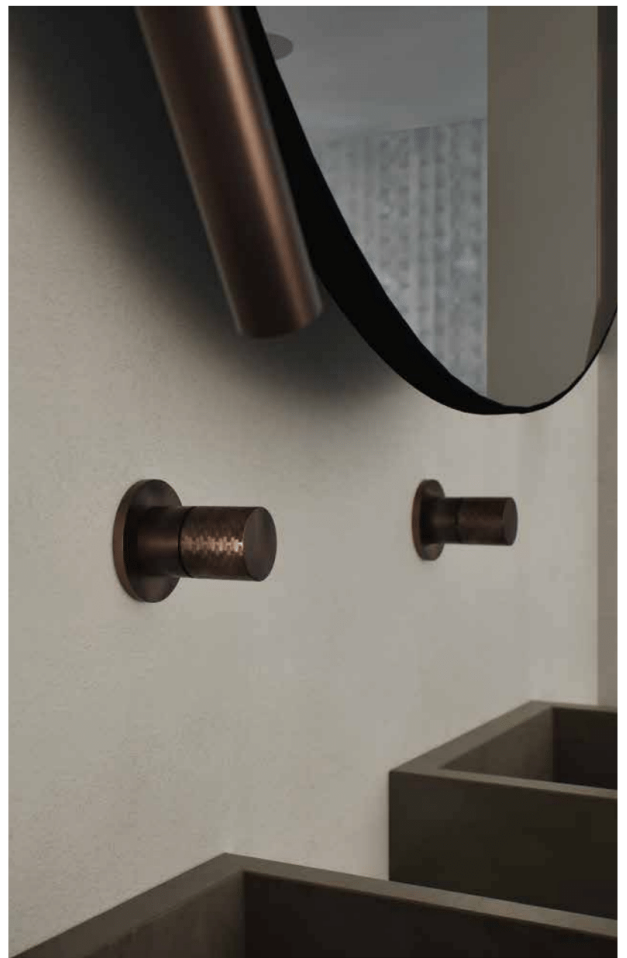

CAPSULE



LAVABO / WASHBASIN
Art. 010078ZGGOR

LAVABO / WASHBASIN
Art. 010078ZGGOR

ACCESSORI / ACCESSORIES
Art. 580018ZGG
Art. 880098ZGG



A parete, la maniglia con le linee sfaccettate di Glow riflette la luce e inaugura nuove esperienze sensoriali. La texture impreziosisce l'ambiente, con un particolare ispirato all'alta gioielleria e all'artigianato.

On the wall, the handle with Glow's faceted lines reflects the light and creates new sensory experiences. The texture embellishes any environment with details inspired by jewelry and craftsmanship.

CAPSULE

La tonalità
ramata dialoga
alla perfezione
con superfici e arredi,
adattandosi a ogni
stile abitativo.



DOCCIA / SHOWER
Art. 88551B2GGAD

THE COPPER SHADE PERFECTLY
FITS IN WITH SURFACES AND
FURNISHINGS, ADAPTING TO
ANY LIVING STYLE.

LAVABO / WASHBASIN
Art. 01007B2GGOR

DOCCIA / SHOWER
Art. 88551B2GGAD
Art. 88642B2GG03
Art. 00590S200
Art. 00688B210/15/20
Art. 00688CN10/15/20
Art. 00688FA10/15/20



CAPSULE

LAVABO / WASHBASIN
Art. 01007B2GGOR

ACCESSORI / ACCESSORIES
Art. 880070PCC60

bonqo

LAVABO / WASHBASIN
Art. 88400R2GG

Il movimento della maniglia crea una cascata di rifrazioni e accenti luminosi che valorizza l'unicità del bagno.

The handle's movement creates a cascade of glares and bright accents enhancing the bathroom's uniqueness.





Scanalature
verticali
ispirate ai tessuti
cannellati con forme
pulite e slanciate.

VERTICAL GROOVES INSPIRED
BY RIBBED FABRICS WITH CLEAN
AND SLENDER SHAPES.

VASCA / BATHTUB
Art. 885100PCC
Art. 888300PCC

CAPSULE

VASCA / BATH TUB
 Art. 885100PCC
 Art. 888300PCC
 Art. 009960P100

ACCESSORI / ACCESSORIES
 Art. 880070PGG60

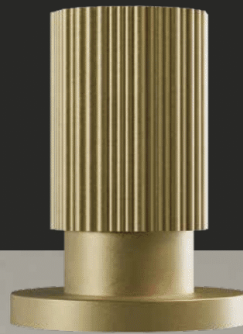

La trama verticale Cannelé non è solo elemento decorativo, ma migliora l'ergonomia della maniglia, facilitandone la presa.

Cannelé's vertical pattern is not just a decorative element. It improves the handle's ergonomics, enhancing grip.



CAPSULE

VASCA / BATHTUB
Art. 885100PCC
Art. 009960P100



L'abbinamento tra le maniglie e la rubinetteria nella finitura galvanica Oro Spazzolato trova nel colore e nei riflessi la propria forza espressiva.

The combination of handles and taps in the Brushed Gold galvanic finish finds its expressive strength in its color and glares.

VASCA / BATHTUB
Art. 885100PCC

CAPSULE

La luce riflessa
sulla texture
Canneté delinea
uno stile
ben definito
e dona carattere
all'intera
area lavabo.

THE LIGHT REFLECTED
ON THE CANNÉTÉ'S TEXTURE
OUTLINES A WELL-DEFINED STYLE
AND PROVIDES CHARACTER
TO THE ENTIRE SINK AREA.

LAVABO / WASHBASIN
Art. 884380PCC22

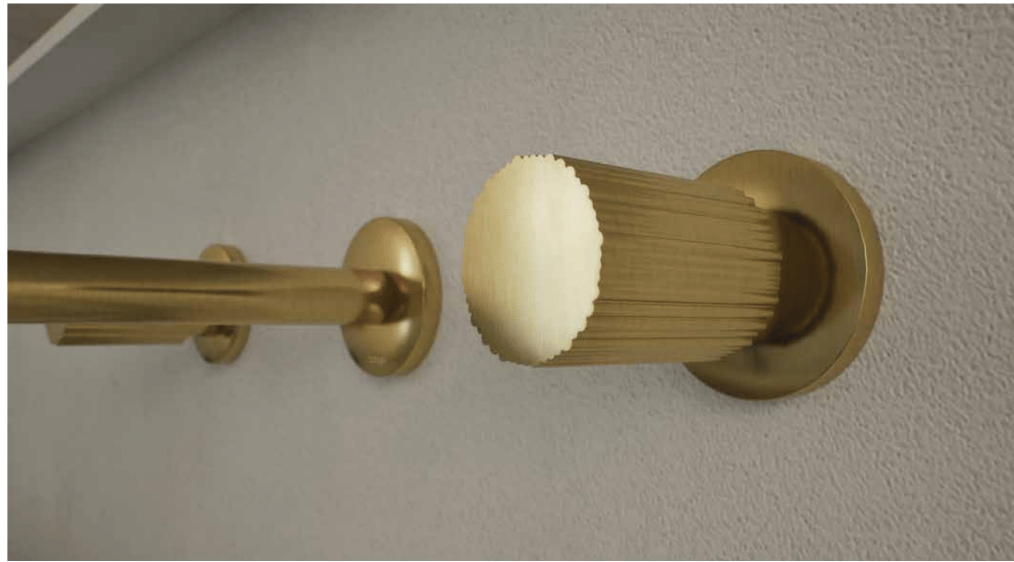

CAPSULE

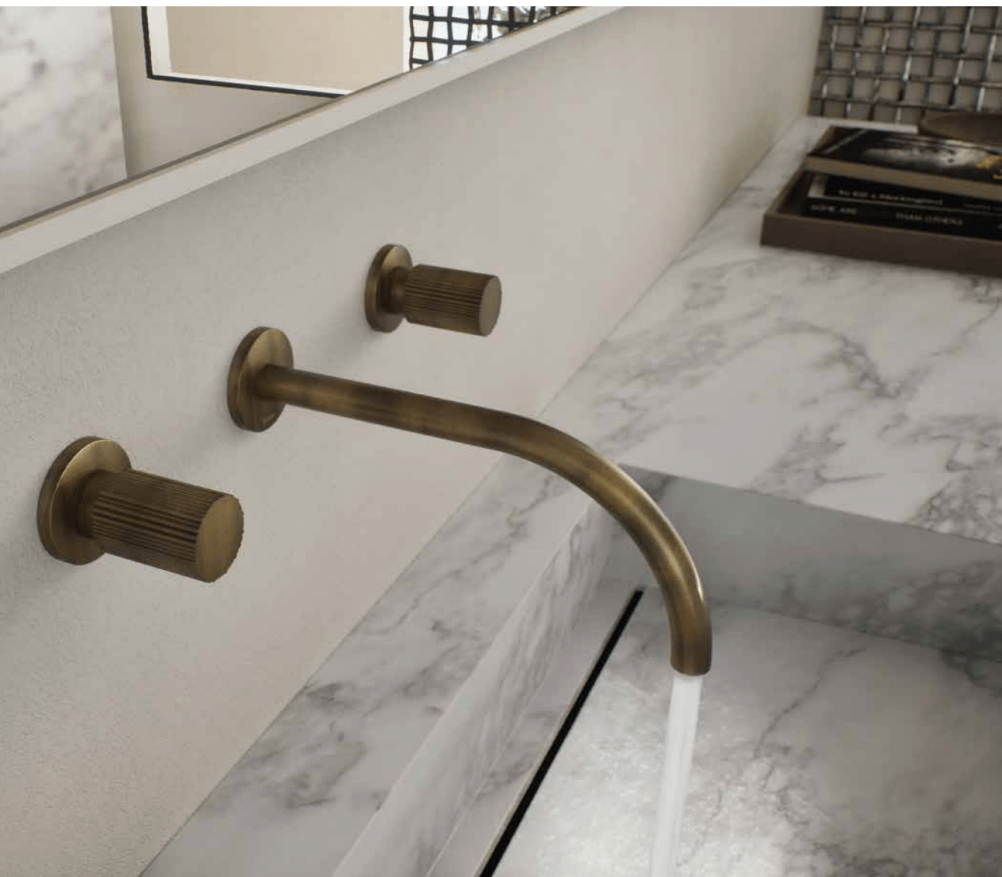

LAVABO / WASHBASIN
Art. 884380PCC22

LAVABO / WASHBASIN
Art. 884388MCC22

CAPSULE

Perle preziose
e rilievi creano
un gioco di luci e ombre
che esalta l'eleganza
del bagno.

PRECIOUS PEARLS AND EMBOSSED
DETAILS CREATE A PLAY OF LIGHT
AND SHADOWS TO HIGHLIGHT
THE BATHROOM'S ELEGANCE.

LAVABO / WASHBASIN
Art. 88538CNGAZA

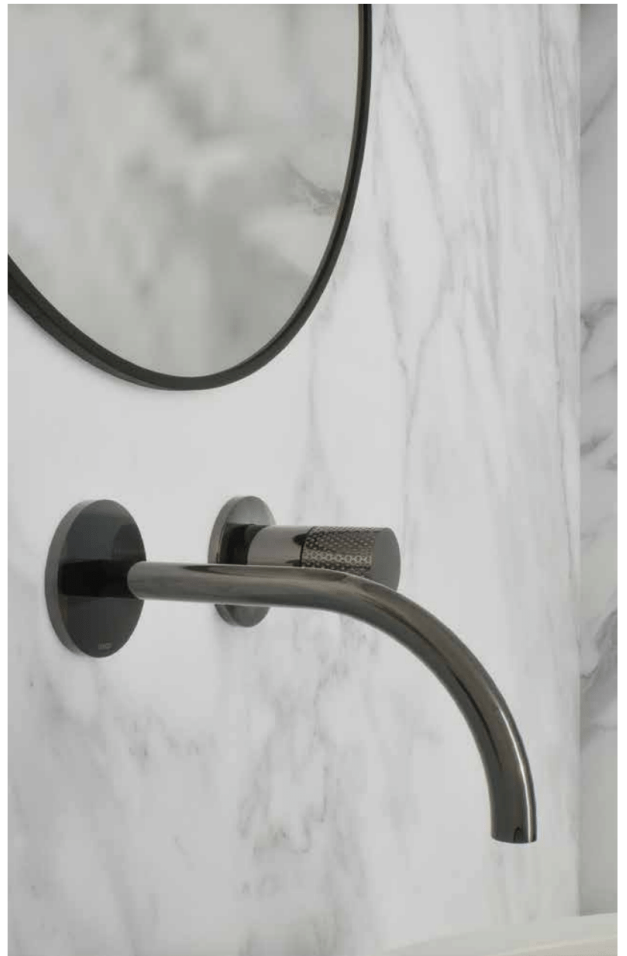

CAPSULE



CAPSULE

DOCCIA / SHOWER
 Art. 88642CNGA04
 Art. 88830CNGA



bonqo

La trama di Grain
 mette in risalto l'esclusività
 e il carattere di ogni ambiente,
 con un tratto distintivo.

Grain's texture brings out exclusivity
 and character in any environment thanks
 to its distinctive feature.



CAPSULE



La finitura Cromo Nero dona alla superficie di Grain un effetto specchiato che impreziosisce maniglie e accessori.

LAVABO / WASHBASIN
Art. 88538CNGA22

The Black Chrome finish gives Grain's surface a mirrored effect embellishing handles and accessories.

ACCESSORI / ACCESSORIES
Art. 88001CNGA
Art. 88007CNGA60

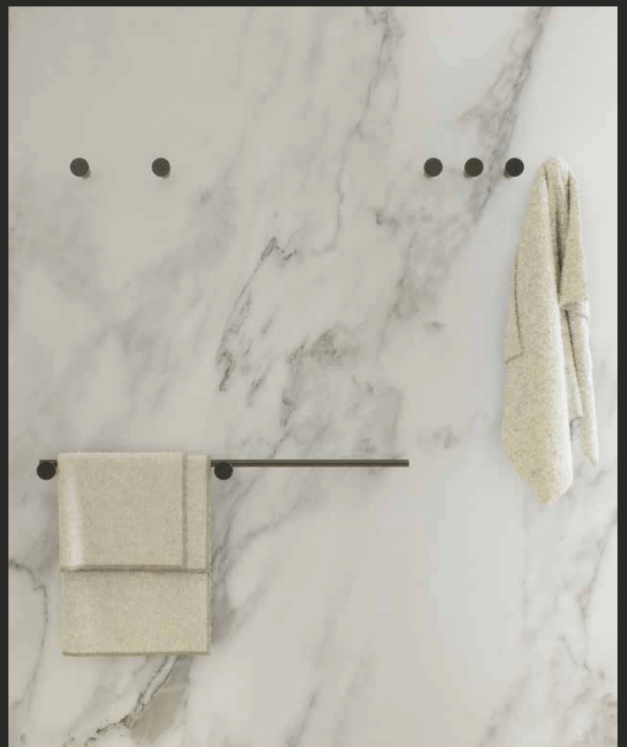



La tridimensionalità della superficie crea un elemento prezioso da sfoggiare, regalando un'esperienza tattile unica.

The surface's three-dimensionality is a precious feature to show off, offering a unique tactile experience.

LAVABO / WASHBASIN
Art. 8853883G02Z

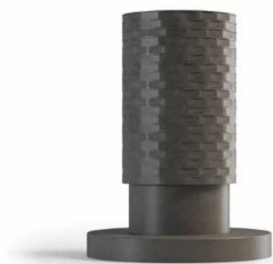

INFORMAZIONI TECNICHE

Technical details



CARTUCCIA: La serie Capsule è dotata di diverse tipologie di cartucce: cartuccia ø 25 mm, cartuccia ø 35 mm senza distributore.

VITONI: La serie Capsule è dotata di vitoni a dischi ceramici da 1/4 giro.

La temperatura d'impianto non deve superare i 70°C. La pressione di esercizio dell'impianto consigliata è di 3 bar.

EROGAZIONE: La serie Capsule ha un tipo di erogazione morbida. I lavabi e i bidet sono forniti con limitatore di portata da 6l/m.

SISTEMI DI DEVIAZIONE: I deviatori Bongio sono testati per funzionare da un minimo di 0,5 bar pressione.

INSTALLAZIONE: Tutti gli articoli ad incasso Bongio completi sono forniti di relative parti da incassare.

Gli articoli doccia e vasca esterni hanno un interasse di 15x20 mm.

Per gli articoli lavabo e bidet, monoforo e tre fori, da installarsi su piano devono essere realizzati fori di ø 35 mm. massimo.

NOTA FINITURE FA / TT

I prodotti nelle finiture Ferro Antico (FA) e Terra di Toscana (TT) vengono realizzati con trattamenti manuali e, data la particolare lavorazione artigianale, possono presentare una colorazione non uniforme.

CARTRIDGE: Capsule series uses different kind of cartridges: ø 25 mm, ø 35mm without distributor.

MECHANISM: Capsule series has 1/4° turn ceramic disc mechanism.

The temperature of the plant should not exceed 70 degrees. The suggested working pressure of the plant has to be 3 bar.

SUPPLY: Capsule series has a soft supply. Basin and bidet mixers have a standard limitation of flow to 6l/m.

DIVERTING SYSTEMS: Bongio diverters have been tested to work properly starting from a minimum 0.5 bar pressure

INSTALLATION: all the built-in Bongio items are available with universal raw built-in body.

All the external shower and bath mixers have the 15x20 mm. interaxe.

For the basin and bidet mixers - single or three holes - to be place on top deck, they require ø 35 mm maximum holes.

FINISHES NOTE FA / TT

Products in Ferro Antico (FA) and Terra di Toscana (TT) finish are made with manual treatments and may therefore display colour variations due to the particular craftsmanship.

MANIGLIE / LEVERS



GG
Glow



CC
Canneté



GA
Grain

FINITURE E COLORI / FINISHES AND COLOURS



Schede tecniche e istruzioni di montaggio sono consultabili e scaricabili sul sito www.bongio.com
Technical features and assembly instructions are available online. Download on www.bongio.com

88 CAPSULE

MANIGLIE / HANDLES

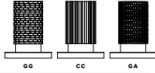

88401

Gruppo lavabo tre fori con piletta clic-clac.

Three holes basin mixer with clic-clac waste.

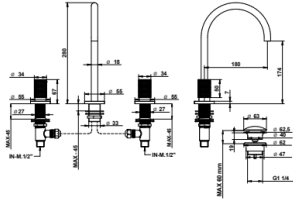

ARTICOLO COMPLETO / COMPLETE ITEM

- 88401CRGG**
CRGG/CRCC/CRGA
- 88401PLGG**
PLGG/PLCC/PLGA/NSGG/NSCC/NSGA
- 88401B1GG**
B1GG/B1CC/B1GA/B2GG/B2CC/B2GA/B3GG/B3CC/
B3GA/B4GG/B4CC/B4GA/NEGG/NECC/NEGA/B1GG/
B1CC/B1GA/H0GG/H0CC/H0GA/E0GG/E0CC/
E0GA/AUGG/AUCC/AUGA/M1GG/M1CC/M1GA
- 88401ZGG**
C2GG/C2CC/C2GA/C3GG/C3CC/C3GA/C4GG/C4CC/
C4GA/ORG/ORCC/ORG/ORG/CNCG/CNCC/CNGA/
OAGG/OACC/DAGA
- 88401FAGG**
FAGG/FACC/FAGA/BMGG/BMCC/BMGA/APGG/
APCC/APGA/OPGG/OPCC/OPGA

Non disponibile in altre finiture. / Not available in other finishes.

ABBINABILE A / TO MATCH WITH:
Sifone / Siphon - 00067

RICAMBI / SPARE PARTS



* Calda / Hot
* Fredda / Cold

88401/H

Gruppo lavabo tre fori con bocca alta e piletta clic-clac.

Three holes basin mixer with high spout and clic-clac waste.

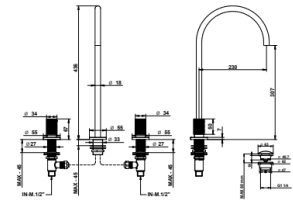

ARTICOLO COMPLETO / COMPLETE ITEM

- 88401CRGGH**
CRGG/CRCC/CRGA
- 88401PLGGH**
PLGG/PLCC/PLGA/NSGG/NSCC/NSGA
- 88401B1GGH**
B1GG/B1CC/B1GA/B2GG/B2CC/B2GA/B3GG/B3CC/
B3GA/B4GG/B4CC/B4GA/NEGG/NEGA/NECC/NEGG/
B1CC/B1GA/H0GG/H0CC/H0GA/E0GG/E0CC/
E0GA/AUGG/AUCC/AUGA/M1GG/M1CC/M1GA
- 88401ZGGH**
C2GG/C2CC/C2GA/C3GG/C3CC/C3GA/C4GG/C4CC/
C4GA/ORG/ORCC/ORG/ORG/CNCG/CNCC/CNGA/
OAGG/OACC/DAGA
- 88401FAGGH**
FAGG/FACC/FAGA/BMGG/BMCC/BMGA/APGG/
APCC/APGA/OPGG/OPCC/OPGA

Non disponibile in altre finiture. / Not available in other finishes.

ABBINABILE A / TO MATCH WITH:
Sifone / Siphon - 00067

RICAMBI / SPARE PARTS



* Calda / Hot
* Fredda / Cold

FINITURE E COLORI / FINISHES AND COLOURS



bonqo

CAPSULE

MANIGLIE / HANDLES

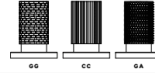

88501

Gruppo lavabo bordo piano 2 fori con piletta clic-clac.

Two holes basin mixer with clic-clac waste.

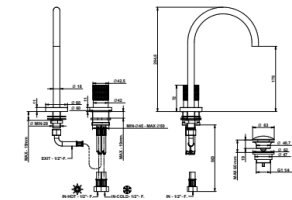

ARTICOLO COMPLETO / COMPLETE ITEM

- 88501CRGG**
CRGG/CRCC/CRGA
- 88501PLGG**
PLGG/PLCC/PLGA/NSGG/NSCC/NSGA
- 88501B1GG**
B1GG/B1CC/B1GA/B2GG/B2CC/B2GA/B3GG/B3CC/
B3GA/B4GG/B4CC/B4GA/NEGG/NECC/NEGA/B1GG/
B1CC/B1GA/H0GG/H0CC/H0GA/E0GG/E0CC/
E0GA/AUGG/AUCC/AUGA/M1GG/M1CC/M1GA
- 88501ZGG**
C2GG/C2CC/C2GA/C3GG/C3CC/C3GA/C4GG/C4CC/
C4GA/ORG/ORCC/ORG/ORG/CNCG/CNCC/CNGA/
OAGG/OACC/DAGA
- 88501FAGG**
FAGG/FACC/FAGA/BMGG/BMCC/BMGA/APGG/
APCC/APGA/OPGG/OPCC/OPGA

Non disponibile in altre finiture. / Not available in other finishes.

ABBINABILE A / TO MATCH WITH:
Sifone / Siphon - 00067

RICAMBI / SPARE PARTS



88501/H

Gruppo lavabo bordo piano 2 fori con bocca alta e piletta clic-clac.

Two holes basin mixer with high spout and clic-clac waste.

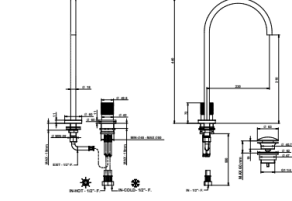

ARTICOLO COMPLETO / COMPLETE ITEM

- 88501CRGGH**
CRGG/CRCC/CRGA
- 88501PLGGH**
PLGG/PLCC/PLGA/NSGG/NSCC/NSGA
- 88501B1GGH**
B1GG/B1CC/B1GA/B2GG/B2CC/B2GA/B3GG/B3CC/
B3GA/B4GG/B4CC/B4GA/NEGG/NEGA/NECC/NEGG/
B1CC/B1GA/H0GG/H0CC/H0GA/E0GG/E0CC/
E0GA/AUGG/AUCC/AUGA/M1GG/M1CC/M1GA
- 88501ZGGH**
C2GG/C2CC/C2GA/C3GG/C3CC/C3GA/C4GG/C4CC/
C4GA/ORG/ORCC/ORG/ORG/CNCG/CNCC/CNGA/
OAGG/OACC/DAGA
- 88501FAGGH**
FAGG/FACC/FAGA/BMGG/BMCC/BMGA/APGG/
APCC/APGA/OPGG/OPCC/OPGA

Non disponibile in altre finiture. / Not available in other finishes.

ABBINABILE A / TO MATCH WITH:
Sifone / Siphon - 00067

RICAMBI / SPARE PARTS

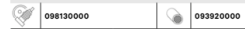

ACCESSORI E RICAMBI / ACCESSORIES AND SPARE PARTS



88 CAPSULE

MANIGLIE / HANDLES

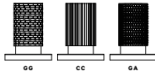

88403
Gruppo bidet tre fori con piletta clic-clac.
Three holes bidet mixer with clic-clac waste.

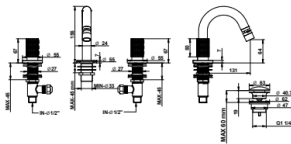

ARTICOLO COMPLETO / COMPLETE ITEM

88403CRGG
CRGG/CRCC/CRGA

88403PLGG
PLGG/PLCC/PLGA/NSGG/NSCC/NSGA

88403B1GG
B1GG/B1CC/B1GA/B2GG/B2CC/B2GA/B3GG/B3CC/
B3GA/B4GG/B4CC/B4GA/NEGG/NECC/NEGA/B5GG/
B5CC/B5GA/H0GG/H0CC/H0GA/E0GG/E0CC/
E0GA/AUGG/AUCC/AUGA/M1GG/M1CC/M1GA

88403C2GG
C2GG/C2CC/C2GA/C3GG/C3CC/C3GA/C4GG/C4CC/
C4GA/DRGG/DRCC/DRGA/CNCG/CNCC/CNGA/
OAGG/OACC/OAGA

88403FAGG
FAGG/FACC/FAGA/BMGG/BMCC/BMGA/APGG/
APCC/APGA/OPGG/OPCC/OPGA

Non disponibile in altre finiture. / Not available in other finishes.
ABBINABILE A / TO MATCH WITH:
Sifone / Siphon - **00066**

RICAMBI / SPARE PARTS

09790000 *	09790000 °
09980CR00	09980XX00 °

* Calda / Hot
° Fredda / Cold
° Ricambio per finiture diverse dal cromo. / Spare part for different finishes.

88503

Gruppo bidet con bocca da piano, miscelatore incasso a muro e piletta clic-clac.
Bidet set with deck spout, built-in mixer and clic-clac waste.

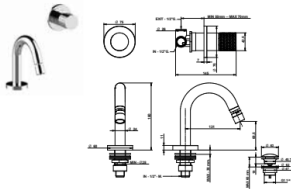

OPTIONAL: Scatola incasso per cartongesso / Built-in box for drywall and cavity wall **09702PBOX**

PROLUNGA / MIXER EXTENSION

81100CRPPR	81100XXPPR *
-------------------	---------------------

RICAMBI / SPARE PARTS

098130000	09980CR00
09980XX00 *	

* Ricambio/prolunga per finiture diverse dal cromo. / Spare part/mixer extension for different finishes.

FINITURE E COLORI / FINISHES AND COLOURS



CAPSULE

MANIGLIE / HANDLES

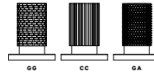

88438/22
Gruppo lavabo a parete con bocca 229 mm.
Wall basin mixer with 229 mm. spout.

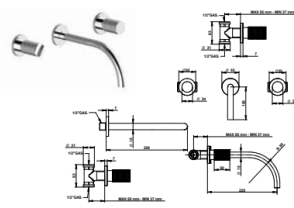

ABBINABILE A / TO MATCH WITH:
Sifone / Siphon - **00067**
Piletta clic-clac / Clic-clac waste - **00079**

PROLUNGA / MIXER EXTENSION

000830000	000830000
------------------	------------------

2 pz. per articolo / 2 pcs needed
Cadm. / Each

RICAMBI / SPARE PARTS

09790000 *	09790000 °
093920000	

* Calda / Hot
° Fredda / Cold

88538/22

Miscelatore lavabo incasso con bocca 229 mm.
Built-in basin mixer with 229 mm. spout.

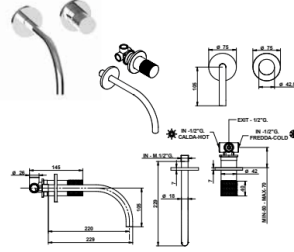

PROLUNGA / MIXER EXTENSION

81100CRPPR	81100XXPPR
-------------------	-------------------

RICAMBI / SPARE PARTS

098130000	093920000
------------------	------------------

ACCESSORI E RICAMBI / ACCESSORIES AND SPARE PARTS

PROLUNGA / MIXER EXTENSION	CARTUCCIA E VITONE / CARTRIDGE AND MECHANISM	AERATORE / AERATOR	FLESSIBILE / FLEXIBLE	DOCCETTA / HANDSHOWER	DEVIATORE / DIVERTER	CAUCIÙ / CAUCIÙ
----------------------------	--	--------------------	-----------------------	-----------------------	----------------------	-----------------

ARTICOLO COMPLETO / COMPLETE ITEM

88438CRGG22
CRGG/CRCC/CRGA

88438PLGG22EU
PLGG/PLCC/PLGA/NSGG/NSCC/NSGA

88438B1GG22EU
B1GG/B1CC/B1GA/B2GG/B2CC/B2GA/B3GG/B3CC/
B3GA/B4GG/B4CC/B4GA/NEGG/NECC/NEGA/B5GG/
B5CC/B5GA/H0GG/H0CC/H0GA/E0GG/E0CC/E0GA/
AUGG/AUCC/AUGA/M1GG/M1CC/M1GA

88438C2GG22EU
C2GG/C2CC/C2GA/C3GG/C3CC/C3GA/C4GG/C4CC/
C4GA/DRGG/DRCC/DRGA/CNCG/CNCC/CNGA/
OAGG/OACC/OAGA

88438FAGG22EU
FAGG/FACC/FAGA/BMGG/BMCC/BMGA/APGG/
APCC/APGA/OPGG/OPCC/OPGA

Non disponibile in altre finiture. / Not available in other finishes.

RICAMBI / SPARE PARTS

09790000 *	09790000 °
093920000	

* Calda / Hot
° Fredda / Cold

ARTICOLO COMPLETO / COMPLETE ITEM

88538CRGG22
CRGG/CRCC/CRGA

88538PLGG22EU
PLGG/PLCC/PLGA/NSGG/NSCC/NSGA

88538B1GG22EU
B1GG/B1CC/B1GA/B2GG/B2CC/B2GA/B3GG/B3CC/
B3GA/B4GG/B4CC/B4GA/NEGG/NECC/NEGA/B5GG/
B5CC/B5GA/H0GG/H0CC/H0GA/E0GG/E0CC/E0GA/
AUGG/AUCC/AUGA/M1GG/M1CC/M1GA

88538C2GG22EU
C2GG/C2CC/C2GA/C3GG/C3CC/C3GA/C4GG/C4CC/
C4GA/DRGG/DRCC/DRGA/CNCG/CNCC/CNGA/
OAGG/OACC/OAGA

88538FAGG22EU
FAGG/FACC/FAGA/BMGG/BMCC/BMGA/APGG/
APCC/APGA/OPGG/OPCC/OPGA

Non disponibile in altre finiture. / Not available in other finishes.

RICAMBI / SPARE PARTS

098130000	093920000
------------------	------------------

* Ricambio/prolunga per finiture diverse dal cromo. / Spare part/mixer extension for different finishes.

ABBINABILE A / TO MATCH WITH:
Sifone / Siphon - **00067**
Piletta clic-clac / Clic-clac waste - **00079**

88 CAPSULE

MANIGLIE / HANDLES

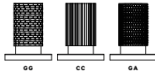

88538/2A

Miscelatore lavabo incasso con bocca 229 mm completo di connessioni incasso.

Built-in basin mixer with 229 mm. spout, complete with built-in connections.



ARTICOLO COMPLETO / COMPLETE ITEM

88538CRGG2A
CRGG/CRCC/CRGA

PARTE INCASSO

BUILT-IN PART

096900000

PARTE ESTERNA DA ABBINARE

EXTERNAL MATCHING PART

FINITURE / FINISHES

88538CRGG2AEU

CRGG/CRCC/CRGA

88538PLGG2AEU

PLGG/PLCC/PLGA/NSGG/
NSCC/NSGA

88538B1GG2AEU

B1GG/B1CC/B1GA/B2GG/
B2CC/B2GA/B3GG/B3CC/
B3GA/B4GG/B4CC/B4GA/
NEGG/NECC/NEGA/B1GG/
B1CC/B1GA/H0GG/H0CC/
H0GA/E0GG/E0CC/E0GA/
AUGG/AUCC/AUGA/M1GG/
M1CC/M1GA

88538C2GG2AEU

C2GG/C2CC/C2GA/C3GG/
C3CC/C3GA/C4GG/C4CC/
C4GA/ORGG/ORCC/ORGA/
CN5G/CN5CC/CN5GA/OAGG/
OAGC/OAGA

88538FAGG2AEU

FAGG/FACC/FAGA/BMGG/
BMCC/BMGA/APGG/APCC/
APGA/OPGG/OPCC/OPGA

Non disponibile in altre finiture. / Not available in other finishes.

ABBINABILE A / TO MATCH WITH:

Sifone / Siphon - 00067

Piletta clic-clac / Clic-clac waste - 00079

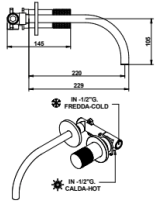
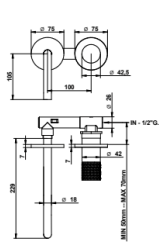

OPTIONAL: Scatola incasso per cartongesso / Built-in box for drywall and cavity wall - 09703PBOX

PROLUNGA / MIXER EXTENSION

81100CRPRPR

81100XPRPR

RICAMBI / SPARE PARTS

098130000

093920000

FINITURE E COLORI / FINISHES AND COLOURS



CAPSULE

MANIGLIE / HANDLES

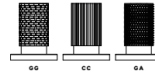

88321

Miscelatore lavabo con piletta clic-clac.

Basin Mixer with clic-clac waste.

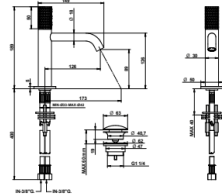

ARTICOLO COMPLETO / COMPLETE ITEM

88321CRGG

CRGG/CRCC/CRGA

88321PLGG

PLGG/PLCC/PLGA/NSGG/NSCC/NSGA

88321B1GG

B1GG/B1CC/B1GA/B2GG/B2CC/B2GA/B3GG/B3CC/
B3GA/B4GG/B4CC/B4GA/NEGG/NECC/NEGA/B1GG/
B1CC/B1GA/H0GG/H0CC/H0GA/E0GG/E0CC/
E0GA/AUGG/AUCC/AUGA/M1GG/M1CC/M1GA

88321C2GG

C2GG/C2CC/C2GA/C3GG/C3CC/C3GA/C4GG/C4CC/
C4GA/ORGG/ORCC/ORGA/CN5G/CN5CC/CN5GA/
OAGG/OAGC/OAGA

88321FAGG

FAGG/FACC/FAGA/BMGG/BMCC/BMGA/APGG/
APCC/APGA/OPGG/OPCC/OPGA

Non disponibile in altre finiture. / Not available in other finishes.

ABBINABILE A / TO MATCH WITH:

Sifone / Siphon - 00067

RICAMBI / SPARE PARTS

098700000

093920000

88332

Miscelatore lavabo alto con bocca lunga e piletta clic-clac.

High basin mixer with long spout and clic-clac waste.

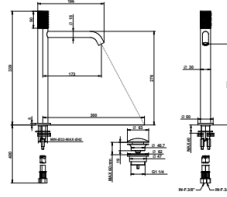

ARTICOLO COMPLETO / COMPLETE ITEM

88332CRGG

CRGG/CRCC/CRGA

88332PLGG

PLGG/PLCC/PLGA/NSGG/NSCC/NSGA

88332B1GG

B1GG/B1CC/B1GA/B2GG/B2CC/B2GA/B3GG/B3CC/
B3GA/B4GG/B4CC/B4GA/NEGG/NECC/NEGA/B1GG/
B1CC/B1GA/H0GG/H0CC/H0GA/E0GG/E0CC/
E0GA/AUGG/AUCC/AUGA/M1GG/M1CC/M1GA

88332C2GG

C2GG/C2CC/C2GA/C3GG/C3CC/C3GA/C4GG/C4CC/
C4GA/ORGG/ORCC/ORGA/CN5G/CN5CC/CN5GA/
OAGG/OAGC/OAGA

88332FAGG

FAGG/FACC/FAGA/BMGG/BMCC/BMGA/APGG/
APCC/APGA/OPGG/OPCC/OPGA

Non disponibile in altre finiture. / Not available in other finishes.

ABBINABILE A / TO MATCH WITH:

Sifone / Siphon - 00067

RICAMBI / SPARE PARTS

098700000

093920000

ACCESSORI E RICAMBI / ACCESSORIES AND SPARE PARTS



88 CAPSULE

MANIGLIE / HANDLES

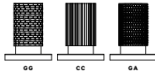

88533

Miscelatore lavabo a pavimento. Floor mounted basin mixer.

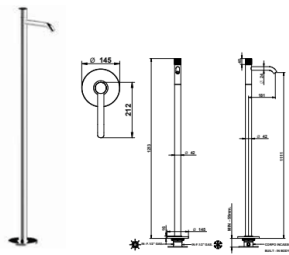

ABBINABILE A / TO MATCH WITH:
Sifone / Siphon - 00007
Piletta clic-clac / Clic-clac waste - 00079

RICAMBI / SPARE PARTS



* Ricambio per finiture diverse dal cromo. / Spare part for different finishes.

88322

Miscelatore bidet con piletta clic-clac. Bidet mixer with clic-clac waste.

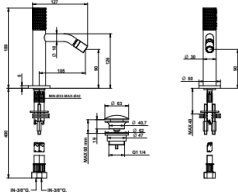

ARTICOLO COMPLETO / COMPLETE ITEM

88533CRGG
CRGG/CRCC/CRGA

PARTE INCASSO
BUILT-IN PART

097440000

PARTE ESTERNA DA ABBINARE
EXTERNAL MATCHING PART

FINITURE / FINISHES

88533CRGG0EU
CRGG/CRCC/CRGA

88533PLGG0EU
PLGG/PLCC/PLGA/NSGG/
NSCC/NSGA

88533B1GG0EU
B1GG/B1CC/B1GA/B2GG/
B2CC/B2GA/B3GG/B3CC/
B3GA/B4GG/B4CC/B4GA/
NEGG/NECC/NEGA/B1GG/
B1CC/B1GA/HOGG/HOCC/
HOGA/EOGG/EOCC/EOGA/
AUGG/AUCC/AUGA/M1GG/
M1CC/M1GA

88533C2GG0EU
C2GG/C2CC/C2GA/C3GG/
C3CC/C3GA/C4GG/C4CC/
C4GA/ORGG/ORCC/ORGA/
CNCG/CNCC/CNGA/DAGG/
DACC/OAGA

88533FAGG0EU
FAGG/FACC/FAGA/BMGG/
BMCC/BMGA/APGG/APCC/
APGA/OPGG/OPCC/OPGA

Non disponibile in altre finiture. / Not available in other finishes.

ARTICOLO COMPLETO / COMPLETE ITEM

88322CRGG
CRGG/CRCC/CRGA

88322PLGG
PLGG/PLCC/PLGA/NSGG/NSCC/NSGA

88322B1GG
B1GG/B1CC/B1GA/B2GG/B2CC/B2GA/B3GG/B3CC/
B3GA/B4GG/B4CC/B4GA/NEGG/NECC/NEGA/B1GG/
B1CC/B1GA/HOGG/HOCC/HOGA/EOGG/EOCC/
EOGA/AUGG/AUCC/AUGA/M1GG/M1CC/M1GA

88322C2GG
C2GG/C2CC/C2GA/C3GG/C3CC/C3GA/C4GG/C4CC/
C4GA/ORGG/ORCC/ORGA/CNCG/CNCC/CNGA/
OAGG/OACC/OAGA

88322FAGG
FAGG/FACC/FAGA/BMGG/BMCC/BMGA/APGG/
APGA/OPGG/OPCC/OPGA

Non disponibile in altre finiture. / Not available in other finishes.

ABBINABILE A / TO MATCH WITH:
Sifone / Siphon - 00066

RICAMBI / SPARE PARTS



* Ricambio per finiture diverse dal cromo. / Spare part for different finishes.

FINITURE E COLORI / FINISHES AND COLOURS



bonqo

CAPSULE

MANIGLIE / HANDLES

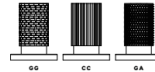

88570

Gruppo lavello miscelatore a parete con bocca girevole, lunghezza 342 mm. Wall built-in mixer with swivel spout, 342 mm long.

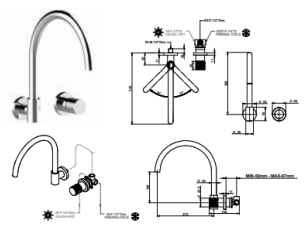

PROLUNGA / MIXER EXTENSION



* Ricambio/prorlunga per finiture diverse dal cromo. / Spare part/mixer extension for different finishes.

RICAMBI / SPARE PARTS



88570/DS

Gruppo lavello miscelatore a parete con bocca girevole, lunghezza 240 mm. Wall built-in mixer with swivel spout, 240 mm long.

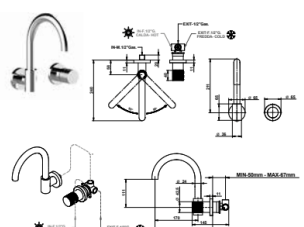

PROLUNGA / MIXER EXTENSION



* Ricambio/prorlunga per finiture diverse dal cromo. / Spare part/mixer extension for different finishes.

RICAMBI / SPARE PARTS



ARTICOLO COMPLETO / COMPLETE ITEM

88570CRGG
CRGG/CRCC/CRGA

PARTE INCASSO
BUILT-IN PART

097610000

PARTE ESTERNA DA ABBINARE
EXTERNAL MATCHING PART

FINITURE / FINISHES

88570CRGG0EU
CRGG/CRCC/CRGA

88570PLGG0EU
PLGG/PLCC/PLGA/NSGG/
NSCC/NSGA

88570B1GG0EU
B1GG/B1CC/B1GA/B2GG/
B2CC/B2GA/B3GG/B3CC/
B3GA/B4GG/B4CC/B4GA/
NEGG/NECC/NEGA/B1GG/
B1CC/B1GA/HOGG/HOCC/
HOGA/EOGG/EOCC/EOGA/
AUGG/AUCC/AUGA/M1GG/
M1CC/M1GA

88570C2GG0EU
C2GG/C2CC/C2GA/C3GG/
C3CC/C3GA/C4GG/C4CC/
C4GA/ORGG/ORCC/ORGA/
CNCG/CNCC/CNGA/DAGG/
DACC/OAGA

88570FAGG0EU
FAGG/FACC/FAGA/BMGG/
BMCC/BMGA/APGG/APCC/
APGA/OPGG/OPCC/OPGA

Non disponibile in altre finiture. / Not available in other finishes.

ARTICOLO COMPLETO / COMPLETE ITEM

88570CRGGDS
CRGG/CRCC/CRGA

PARTE INCASSO
BUILT-IN PART

097610000

PARTE ESTERNA DA ABBINARE
EXTERNAL MATCHING PART

FINITURE / FINISHES

88570CRGG0EU
CRGG/CRCC/CRGA

88570PLGG0EU
PLGG/PLCC/PLGA/NSGG/
NSCC/NSGA

88570B1GG0EU
B1GG/B1CC/B1GA/B2GG/
B2CC/B2GA/B3GG/B3CC/
B3GA/B4GG/B4CC/B4GA/
NEGG/NECC/NEGA/B1GG/
B1CC/B1GA/HOGG/HOCC/
HOGA/EOGG/EOCC/EOGA/
AUGG/AUCC/AUGA/M1GG/
M1CC/M1GA

88570C2GG0EU
C2GG/C2CC/C2GA/C3GG/
C3CC/C3GA/C4GG/C4CC/
C4GA/ORGG/ORCC/ORGA/
CNCG/CNCC/CNGA/DAGG/
DACC/OAGA

88570FAGG0EU
FAGG/FACC/FAGA/BMGG/
BMCC/BMGA/APGG/APCC/
APGA/OPGG/OPCC/OPGA

Non disponibile in altre finiture. / Not available in other finishes.

ACCESSORI E RICAMBI / ACCESSORIES AND SPARE PARTS



88 CAPSULE

MANIGLIE / HANDLES

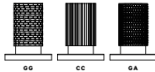

88400

Rubinetto incasso 1/2". 1/2" built-in tap.

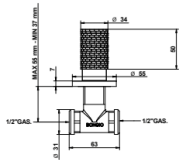

PROLUNGA / MIXER EXTENSION

000830000

RICAMBI / SPARE PARTS

097900000 *

097900000 °

* Calda / Hot
° Fredda / Cold

88498

Rubinetto incasso 3/4" vitone tradizionale. 3/4" built-in tap traditional mechanism.

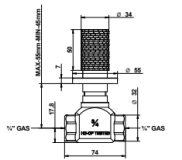
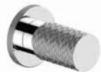

RICAMBI / SPARE PARTS

098040000 *

098040000 °

* Calda / Hot
° Fredda / Cold

FINITURE E COLORI / FINISHES AND COLOURS



ARTICOLO COMPLETO / COMPLETE ITEM

88400CRGG
CRGG/CRCC/CRGA

PARTE INCASSO
BUILT-IN PART

097750000
FREDDA / cold

PARTE ESTERNA DA ABBINARE
EXTERNAL MATCHING PART

FINITURE / FINISHES

88400CRGGEU

CRGG/CRCC/CRGA

88400PLGGEU

PLGG/PLCC/PLGA/NSGG/
NSCC/NSGA

88400B1GGEU

B1GG/B1CC/B1GA/B2GG/
B2CC/B2GA/B2GG/B3CC/
B3GA/B4GG/B4CC/B4GA/
NEG/NECC/NEGA/B1GG/
B1CC/B1GA/HOGG/HOCC/
HOGA/EOGG/EOCC/EOGA/
AUGG/AUCC/AUGA/M1GG/
M1CC/M1GA

88400C2GGEU

C2GG/C2CC/C2GA/C3GG/
C3CC/C3GA/C4GG/C4CC/
C4GA/ORGG/ORCC/ORGA/
CNCG/CNCC/CNGA/OAGG/
DACC/OAGA

88400FAGGEU

FAGG/FACC/FAGA/BMGG/
BMCC/BMGA/APGG/APCC/
APGA/OPGG/OPCC/OPGA

Non disponibile in altre finiture. / Not available in other finishes.

ARTICOLO COMPLETO / COMPLETE ITEM

88498CRGG
CRGG/CRCC/CRGA

PARTE INCASSO
BUILT-IN PART

097720000
CALDA / hot

097720000
FREDDA / cold

PARTE ESTERNA DA ABBINARE
EXTERNAL MATCHING PART

FINITURE / FINISHES

88498CRGGEU

CRGG/CRCC/CRGA

88498PLGGEU

PLGG/PLCC/PLGA/NSGG/
NSCC/NSGA

88498B1GGEU

B1GG/B1CC/B1GA/B2GG/
B2CC/B2GA/B3GG/B3CC/
B3GA/B4GG/B4CC/B4GA/
NEG/NECC/NEGA/B1GG/
B1CC/B1GA/HOGG/HOCC/
HOGA/EOGG/EOCC/EOGA/
AUGG/AUCC/AUGA/M1GG/
M1CC/M1GA

88498C2GGEU

C2GG/C2CC/C2GA/C3GG/
C3CC/C3GA/C4GG/C4CC/
C4GA/ORGG/ORCC/ORGA/
CNCG/CNCC/CNGA/OAGG/
DACC/OAGA

88498FAGGEU

FAGG/FACC/FAGA/BMGG/
BMCC/BMGA/APGG/APCC/
APGA/OPGG/OPCC/OPGA

Non disponibile in altre finiture. / Not available in other finishes.

PROLUNGA / MIXER EXTENSION

000830000

CAPSULE

MANIGLIE / HANDLES

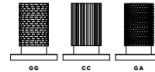

40525/R

Deviatore 2 uscite (2 entrate 2 uscite). 2 exit built-in diverter (2 in - 2 out).

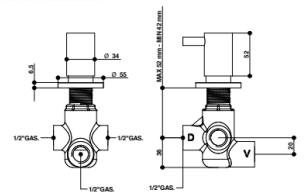

RICAMBI / SPARE PARTS

00112DM

40525/S

Deviatore 3 uscite (2 entrate 3 uscite). 3 exit built-in diverter (2 in - 3 out).

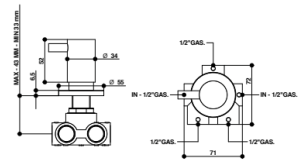

ACCESSORI E RICAMBI / ACCESSORIES AND SPARE PARTS



ARTICOLO COMPLETO / COMPLETE ITEM

40525CRCROR
CRCR

PARTE INCASSO
BUILT-IN PART

094960000

PARTE ESTERNA DA ABBINARE
EXTERNAL MATCHING PART

FINITURE / FINISHES

40525CR09EU

CRCR

40525PL09EU

PLPL/PLNS/AU/AU/EOEO/
HOHO/MI/MI/NE/NE/NSNS

40525B109EU

B1B1/B2B2/B3B3/B4B4/
CN/CN/CC/C3C3/C4C4/
OR/OR/OA/OA/AP/AP/OPOP/
FA/FA

40525XXX09EU *

XXXX

* XX: Per tutte le altre finiture fattibili riferirsi a questa fascia di prezzo. / Refer to this line of price for all other realizable finishes.

Da abbinare ad articolo 40500/40498 e 88400/88498. / To match with 40500/40498 and 88400/88498.

PROLUNGA / MIXER EXTENSION

000830000

ARTICOLO COMPLETO / COMPLETE ITEM

40525CRCR05
CRCR

PARTE INCASSO
BUILT-IN PART

094980000

PARTE ESTERNA DA ABBINARE
EXTERNAL MATCHING PART

FINITURE / FINISHES

40525CR05EU

CRCR

40525PL05EU

PLPL/PLNS/AU/AU/EOEO/
HOHO/MI/MI/NE/NE/BI/BI

40525B105EU

B1B1/B2B2/B3B3/B4B4/
CN/CN/CC/C3C3/C4C4/
OR/OR/OA/OA/AP/AP/OPOP/
FA/FA

40525XXX05EU *

XXXX

* XX: Per tutte le altre finiture fattibili riferirsi a questa fascia di prezzo. / Refer to this line of price for all other realizable finishes.

Da abbinare ad articolo 40500/40498 e 88400/88498. / To match with 40500/40498 and 88400/88498.

PROLUNGA / MIXER EXTENSION

000830000

RICAMBI / SPARE PARTS

00112DM

88 CAPSULE

MANIGLIE / HANDLES

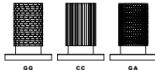

88524

Miscelatore incasso. Built-in mixer.

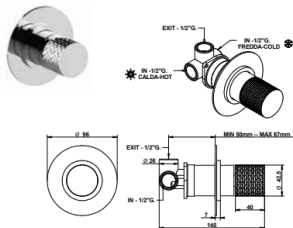

OPTIONAL: Scatola incasso per cartongesso / Built-in box for drywall and cavity wall 09702PBOX

PROLUNGA / MIXER EXTENSION



* Ricambio/prolunga per finiture diverse dal cromo. / Spare part/mixer extension for different finishes.

RICAMBI / SPARE PARTS



88524/RP

Miscelatore incasso con rosone piccolo incasso. Built-in mixer with small flange.

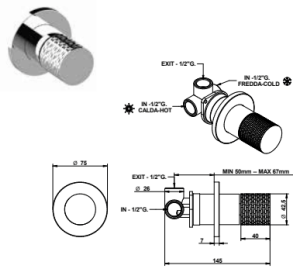

OPTIONAL: Scatola incasso per cartongesso / Built-in box for drywall and cavity wall 09702PBOX

PROLUNGA / MIXER EXTENSION



* Ricambio/prolunga per finiture diverse dal cromo. / Spare part/mixer extension for different finishes.

FINITURE E COLORI / FINISHES AND COLOURS



ARTICOLO COMPLETO / COMPLETE ITEM

88524CRGG
CRGG/CRCC/CRGA

PARTE INCASSO
BUILT-IN PART

097610000

PARTE ESTERNA DA ABBINARE
EXTERNAL MATCHING PART

FINITURE / FINISHES

88524CRGGEU
CRGG/CRCC/CRGA

88524PLGGEU
PLGG/PLCC/PLGA/NSGG/
NSCC/NSGA

88524B1GGEU
B1GG/B1CC/B1GA/B2GG/
B2CC/B2GA/B2GG/B3CC/
B3GA/B4GG/B4CC/B4GA/
NEG/NECC/NEGA/B1GG/
B1CC/B1GA/HOGG/HOCC/
HOGA/EOGG/EOCC/EOGA/
AUGG/AUCC/AUGA/M1GG/
M1CC/M1GA

88524C2GGEU
C2GG/C2CC/C2GA/C3GG/
C3CC/C3GA/C4GG/C4CC/
C4GA/ORGG/ORCC/ORGA/
CNCG/CNCC/CNGA/DAGG/
DACC/DAGA

88524FAGGEU
FAGG/FACC/FAGA/BMGG/
BMCC/BMGA/APGG/APCC/
APGA/OPGG/OPCC/OPGA

Non disponibile in altre finiture. / Not available in other finishes.

ARTICOLO COMPLETO / COMPLETE ITEM

88524CRGGRP
CRGG/CRCC/CRGA

PARTE INCASSO
BUILT-IN PART

097610000

PARTE ESTERNA DA ABBINARE
EXTERNAL MATCHING PART

FINITURE / FINISHES

88524CRGGRPEU
CRGG/CRCC/CRGA

88524PLGGRPEU
PLGG/PLCC/PLGA/NSGG/
NSCC/NSGA

88524B1GGRPEU
B1GG/B1CC/B1GA/B2GG/
B2CC/B2GA/B3GG/B3CC/
B3GA/B4GG/B4CC/B4GA/
NEG/NECC/NEGA/B1GG/
B1CC/B1GA/HOGG/HOCC/
HOGA/EOGG/EOCC/EOGA/
AUGG/AUCC/AUGA/M1GG/
M1CC/M1GA

88524C2GGRPEU
C2GG/C2CC/C2GA/C3GG/
C3CC/C3GA/C4GG/C4CC/
C4GA/ORGG/ORCC/ORGA/
CNCG/CNCC/CNGA/DAGG/
DACC/DAGA

88524FAGGRPEU
FAGG/FACC/FAGA/BMGG/
BMCC/BMGA/APGG/APCC/
APGA/OPGG/OPCC/OPGA

Non disponibile in altre finiture. / Not available in other finishes.

RICAMBI / SPARE PARTS



CAPSULE

MANIGLIE / HANDLES

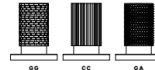

88510

Miscelatore bordo piano. Mixer for deck installation.

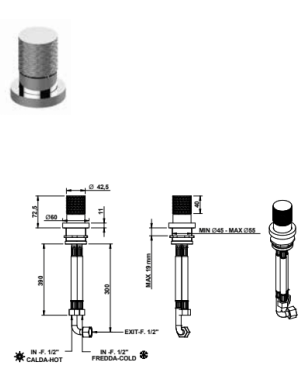

ARTICOLO COMPLETO / COMPLETE ITEM

88510CRGG
CRGG/CRCC/CRGA

PARTE INCASSO
BUILT-IN PART

098130000

PARTE ESTERNA DA ABBINARE
EXTERNAL MATCHING PART

FINITURE / FINISHES

88510CRGGEU
CRGG/CRCC/CRGA

88510PLGGEU
PLGG/PLCC/PLGA/NSGG/
NSCC/NSGA

88510B1GGEU
B1GG/B1CC/B1GA/B2GG/B2CC/B2GA/B3GG/B3CC/
B3GA/B4GG/B4CC/B4GA/NEG/NECC/NEGA/B1GG/
B1CC/B1GA/HOGG/HOCC/HOGA/EOGG/EOCC/
EOGA/AUGG/AUCC/AUGA/M1GG/M1CC/M1GA

88510C2GGEU
C2GG/C2CC/C2GA/C3GG/C3CC/C3GA/C4GG/C4CC/
C4GA/ORGG/ORCC/ORGA/CNCG/CNCC/CNGA/
DAGG/DACC/DAGA

88510FAGGEU
FAGG/FACC/FAGA/BMGG/BMGA/APGG/APCC/
APGA/OPGG/OPCC/OPGA

* Nelle varianti colore verniciate e satinati alcuni particolari saranno in finitura galvanica per garantire gli standard qualitativi. / To assure our quality standard on colored and satin products, some details remain in galvanic finishes.

Non disponibile in altre finiture. / Not available in other finishes.

RICAMBI / SPARE PARTS



88556

Deviatore 2 uscite (1 entrata - 2 uscite). 2 exits diverter (1 in - 2 out).

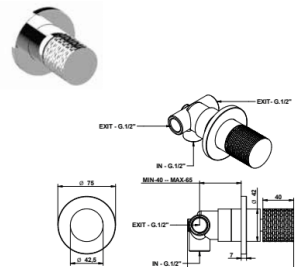

ARTICOLO COMPLETO / COMPLETE ITEM

88556CRGG
CRGG/CRCC/CRGA

PARTE INCASSO
BUILT-IN PART

094910002

PARTE ESTERNA DA ABBINARE
EXTERNAL MATCHING PART

FINITURE / FINISHES

88556CRGGEU
CRGG/CRCC/CRGA

88556PLGGEU
PLGG/PLCC/PLGA/NSGG/
NSCC/NSGA

88556B1GGEU
B1GG/B1CC/B1GA/B2GG/
B2CC/B2GA/B3GG/B3CC/
B3GA/B4GG/B4CC/B4GA/
NEG/NECC/NEGA/B1GG/
B1CC/B1GA/HOGG/HOCC/
HOGA/EOGG/EOCC/EOGA/
AUGG/AUCC/AUGA/M1GG/
M1CC/M1GA

88556C2GGEU
C2GG/C2CC/C2GA/C3GG/
C3CC/C3GA/C4GG/C4CC/
C4GA/ORGG/ORCC/ORGA/
CNCG/CNCC/CNGA/DAGG/
DACC/DAGA

88556FAGGEU
FAGG/FACC/FAGA/BMGG/
BMCC/BMGA/APGG/APCC/
APGA/OPGG/OPCC/OPGA

Non disponibile in altre finiture. / Not available in other finishes.

ABBINABILE A / TO MATCH WITH:
Miscelatore incasso / Built-in mixer - 88524

PROLUNGA / MIXER EXTENSION



RICAMBI / SPARE PARTS



ACCESSORI E RICAMBI / ACCESSORIES AND SPARE PARTS



88 CAPSULE

MANIGLIE / HANDLES

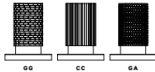

88556/3

Deviatore a 3 uscite (1 entrata - 3 uscite). / 3 exits diverter (1 in - 3 out).

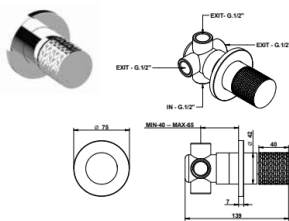

ABBINABILE A / TO MATCH WITH: Miscelatore incasso / Built-in mixer - 88524

PROLUNGA / MIXER EXTENSION

0010900PR

RICAMBI / SPARE PARTS

098080000

ARTICOLO COMPLETO / COMPLETE ITEM

88556CRGG03
CRGG/CRCC/CRGA

PARTE INCASSO
BUILT-IN PART

094940000

PARTE ESTERNA DA ABBINARE
EXTERNAL MATCHING PART

FINITURE / FINISHES

88556CRGG03EU

88556PLGG03EU
PLGG/PLCC/PLGA/NSGG/
NSCC/NSGA

88556B1GG03EU

B1GG/B1CC/B1GA/B2GG/
B2CC/B2GA/B3GG/B3CC/
B3GA/B4GG/B4CC/B4GA/
NEG/NECC/NEGA/B1GG/
B1CC/B1GA/HOGG/HOCC/
HOGA/EOGG/EOCC/EOGA/
AUGG/AUCC/AUGA/MGG/
MCC/MGA

88556C2GG03EU

C2GG/C2CC/C2GA/C3GG/
C3CC/C3GA/C4GG/C4CC/
C4GA/ORG/ORCC/ORGA/
CNG/CNCC/CNGA/OAGG/
OACC/OAGA

88556FAGG03EU

FAGG/FACC/FAGA/BMGG/
BMCC/BMGA/APGG/APCC/
APGA/OPGG/OPCC/OPGA

Non disponibile in altre finiture. / Not available in other finishes.

88519

Miscelatore incasso con deviatore meccanico a 2 uscite. / Built-in mixer with 2 exits mechanical diverter.

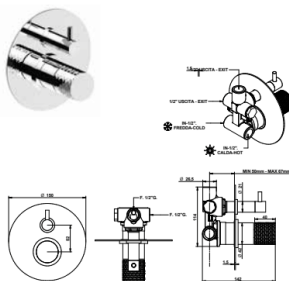

OPZIONALE: Scatola incasso per cartongesso / Built-in box for drywall and cavity wall 09702PB0X

PROLUNGA / MIXER EXTENSION

8102CRPRP3

8102XXPRP3 *

* Ricambio/prolunga per finiture diverse dal cromo. / Spare part/mixer extension for different finishes.

FINITURE E COLORI / FINISHES AND COLOURS



ARTICOLO COMPLETO / COMPLETE ITEM

88519CRGG
CRGG/CRCC/CRGA

PARTE INCASSO
BUILT-IN PART

097630000

PARTE ESTERNA DA ABBINARE
EXTERNAL MATCHING PART

FINITURE / FINISHES

88519CRGG03EU

88519PLGG03EU
PLGG/PLCC/PLGA/NSGG/
NSCC/NSGA

88519B1GG03EU

B1GG/B1CC/B1GA/B2GG/
B2CC/B2GA/B3GG/B3CC/
B3GA/B4GG/B4CC/B4GA/
NEG/NECC/NEGA/B1GG/
B1CC/B1GA/HOGG/HOCC/
HOGA/EOGG/EOCC/EOGA/
AUGG/AUCC/AUGA/MGG/
MCC/MGA

88519C2GG03EU

C2GG/C2CC/C2GA/C3GG/
C3CC/C3GA/C4GG/C4CC/
C4GA/ORG/ORCC/ORGA/
CNG/CNCC/CNGA/OAGG/
OACC/OAGA

88519FAGG03EU

FAGG/FACC/FAGA/BMGG/
BMCC/BMGA/APGG/APCC/
APGA/OPGG/OPCC/OPGA

Non disponibile in altre finiture. / Not available in other finishes.

RICAMBI / SPARE PARTS

098130000

098610000

bonpo

CAPSULE

MANIGLIE / HANDLES

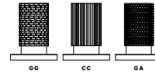

88519/3

Miscelatore incasso con deviatore meccanico a 3 uscite. / Built-in mixer with 3 exits mechanical diverter.

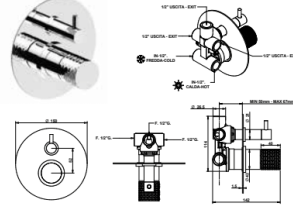

OPZIONALE: Scatola incasso per cartongesso / Built-in box for drywall and cavity wall 09702PB0X

PROLUNGA / MIXER EXTENSION

8102CRPRP3

8102XXPRP3 *

* Ricambio/prolunga per finiture diverse dal cromo. / Spare part/mixer extension for different finishes.

RICAMBI / SPARE PARTS

098130000

098600000

88551/AD

Gruppo incasso completo di connessioni, miscelatore, deviatore e set doccetta con piastra interna per fissaggio semplificato. / Built-in mixer with connection, mixer, diverter and handshower set with easy installation internal plate.

Dettaglio flessibili / Flexible details General Catalogue 2023 pag. 26

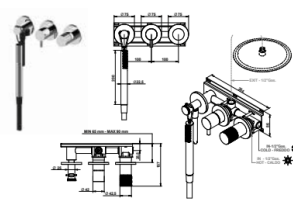

RICAMBI / SPARE PARTS

098130000

09611CR00

09600XXPV *

09600XX00 ¹⁾

88850CR00

88850XX00 ²⁾

098210000

88850CU00

* Per le finiture verniciate o satinato il flessibile verrà fornito in PVC nero. / The flexible hose will be supplied in black PVC for painted and matt finishes.
¹⁾ Ricambio per finiture galvaniche diverse dal cromo. / Spare part for galvanic finishes different from chrome.
²⁾ Ricambio per finiture diverse dal cromo. / Spare part for different finishes.

ACCESSORI E RICAMBI / ACCESSORIES AND SPARE PARTS

PROLUNGA / MIXER EXTENSION

CARTUCCIA E VITONE / CARTRIDGE AND MECHANISM

AERATORE / AERATOR

FLESSIBILE / FLEXIBLE

DOCCETTA / HANDSHOWER

DEVIATORE / DIVERTER

CAUCCIÙ / CAUCIÙ

ARTICOLO COMPLETO / COMPLETE ITEM

88519CRGG03
CRGG/CRCC/CRGA

PARTE INCASSO
BUILT-IN PART

097630000

PARTE ESTERNA DA ABBINARE
EXTERNAL MATCHING PART

FINITURE / FINISHES

88519CRGG03EU

88519PLGG03EU
PLGG/PLCC/PLGA/NSGG/
NSCC/NSGA

88519B1GG03EU

B1GG/B1CC/B1GA/B2GG/
B2CC/B2GA/B3GG/B3CC/
B3GA/B4GG/B4CC/B4GA/
NEG/NECC/NEGA/B1GG/
B1CC/B1GA/HOGG/HOCC/
HOGA/EOGG/EOCC/EOGA/
AUGG/AUCC/AUGA/MGG/
MCC/MGA

88519C2GG03EU

C2GG/C2CC/C2GA/C3GG/
C3CC/C3GA/C4GG/C4CC/
C4GA/ORG/ORCC/ORGA/
CNG/CNCC/CNGA/OAGG/
OACC/OAGA

88519FAGG03EU

FAGG/FACC/FAGA/BMGG/
BMCC/BMGA/APGG/APCC/
APGA/OPGG/OPCC/OPGA

Non disponibile in altre finiture. / Not available in other finishes.

ARTICOLO COMPLETO / COMPLETE ITEM

88519CRGGAD
CRGG/CRCC/CRGA

PARTE INCASSO
BUILT-IN PART

0960000DP

PARTE ESTERNA DA ABBINARE
EXTERNAL MATCHING PART

FINITURE / FINISHES

88519CRGGADEU

88519PLGGADEU
PLGG/PLCC/PLGA/NSGG/
NSCC/NSGA

88519B1GGADEU

B1GG/B1CC/B1GA/B2GG/
B2CC/B2GA/B3GG/B3CC/
B3GA/B4GG/B4CC/B4GA/
NEG/NECC/NEGA/B1GG/
B1CC/B1GA/HOGG/HOCC/
HOGA/EOGG/EOCC/EOGA/
AUGG/AUCC/AUGA/MGG/
MCC/MGA

88519C2GGADEU

C2GG/C2CC/C2GA/C3GG/
C3CC/C3GA/C4GG/C4CC/
C4GA/ORG/ORCC/ORGA/
CNG/CNCC/CNGA/OAGG/
OACC/OAGA

88519FAGGADEU

FAGG/FACC/FAGA/BMGG/
BMCC/BMGA/APGG/APCC/
APGA/OPGG/OPCC/OPGA

Non disponibile in altre finiture. / Not available in other finishes.

PROLUNGA / MIXER EXTENSION

8113CRPR

8113XXPR *

* Ricambio/prolunga per finiture diverse dal cromo. / Spare part/mixer extension for different finishes.

88 CAPSULE

MANIGLIE / HANDLES

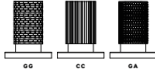

88552/AD

Gruppo incasso completo di connessioni, con piastra interna per fissaggio semplificato; miscelatore, deviatore e set doccia con piastra.

Built-in mixer with connection with easy installation internal plate, mixer, diverter and handshower set with plate.



ARTICOLO COMPLETO / COMPLETE ITEM

88552CRGGAD
CRGG/CRCC/CRGA

PARTE INCASSO
BUILT-IN PART

096900DP

PARTE ESTERNA DA ABBINARE
EXTERNAL MATCHING PART

FINITURE / FINISHES

- 88552CRGGADEU
CRGG/CRCC/CRGA
- 88552PLGGADEU
PLGG/PLCC/PLGA/NSGG/
NSCC/NSGA
- 88552B1GGADEU
B1GG/B1CC/B1GA/B2GG/
B2CC/B2GA/B3GG/B3CC/
B3GA/B4GG/B4CC/B4GA/
NEGG/NECC/NEGA/B1GG/
B1CC/B1GA/H0GG/H0CC/
H0GA/E0GG/E0CC/E0GA/
AUGG/AUCC/AUGA/M1GG/
M1CC/M1GA
- 88552C2GGADEU
C2GG/C2CC/C2GA/C3GG/
C3CC/C3GA/C4GG/C4CC/
C4GA/ORG/ORCC/ORG/
CNGG/CNCC/CNGA/OAGG/
OACC/OAGA
- 88552AGGAEU
FAGG/FACC/FAGA/BMGG/
BMCC/BMGA/APGG/APCC/
APGA/DPGG/DPCC/DPGA

Non disponibile in altre finiture. / Not available in other finishes.

FINITURE E COLORI / FINISHES AND COLOURS



bonqo

CAPSULE

MANIGLIE / HANDLES

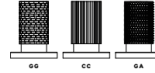

88542/2

Miscelatore termostatico incasso con 2 rubinetti di apertura/chiusura su piastra unica (2 uscite).
Montaggio disponibile sia in verticale che orizzontale.

Built-in thermostatic mixer with 2 open/close taps on single plate (2 exits). Available mounting both vertically and horizontally.



ARTICOLO COMPLETO / COMPLETE ITEM

88542CRGG02
CRGG/CRCC/CRGA

PARTE INCASSO
BUILT-IN PART

09730002

PARTE ESTERNA DA ABBINARE
EXTERNAL MATCHING PART

FINITURE / FINISHES

- 88542CRGG02EU
CRGG/CRCC/CRGA
- 88542PLGG02EU
PLGG/PLCC/PLGA/NSGG/
NSCC/NSGA
- 88542B1GG02EU *
B1GG/B1CC/B1GA/B2GG/
B2CC/B2GA/B3GG/B3CC/
B3GA/B4GG/B4CC/B4GA/
NEGG/NECC/NEGA/B1GG/
B1CC/B1GA/H0GG/H0CC/
H0GA/E0GG/E0CC/E0GA/
AUGG/AUCC/AUGA/M1GG/
M1CC/M1GA
- 88542B2GG02EU *
B2GG/B2CC/B2GA/CNCG/
CNCC/CNGA/OAGG/OACC/
OAGA
- 88542FAGG02EU *
FAGG/FACC/FAGA/APGG/
APCC/APGA/DPGG/DPCC/
DPGA

* Nelle varianti colore verniciate e satinato alcuni particolari saranno in finitura galvanica per garantire gli standard qualitativi. / To assure our quality standard on colored and satin product, some details remain in galvanic finishes.

Non disponibile in altre finiture. / Not available in other finishes.
Portata a pressione dinamica: 3 bar - 23 l/min. / Flow rates at dynamic pressure: 3 bar - 23 l/min.

Media portata. / Average water flow

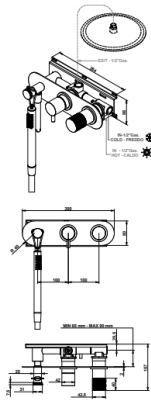

PROLUNGA / MIXER EXTENSION

81113CRPR	81113XXPR *
-----------	-------------

* Ricambio/prolunga per finiture diverse dal cromo. / Spare part/mixer extension for different finishes.

RICAMBI / SPARE PARTS

096130000	09611CR00
09600XPV *	09600XX00 ◊
88850CR00	88850XX00 ◊
098210000	88850CU00

* Per le finiture verniciate e satinete il flessibile verrà fornito in PVC nero. / The flexible hose will be supplied in black PVC for painted and matt finishes.
◊ Ricambio per finiture galvaniche diverse dal cromo. / Spare part for galvanic finishes different from chrome.
◊ Ricambio per finiture diverse dal cromo. / Spare part for different finishes.

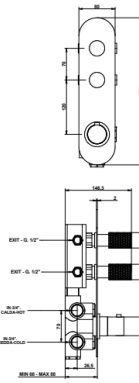

PROLUNGA / MIXER EXTENSION

00112CRPR02	00112XXPR02 *
-------------	---------------

* Ricambio/prolunga per finiture diverse dal cromo. / Spare part/mixer extension for different finishes.

RICAMBI / SPARE PARTS

098450000 *	097940000 ◊
-------------	-------------

* Cartuccia miscelatrice / Mixer cartridge
◊ Vitone di apertura-chiusura / Open-close cartridge

ACCESSORI E RICAMBI / ACCESSORIES AND SPARE PARTS



MANIGLIE / HANDLES

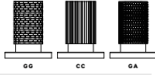

88542/3

Miscelatore termostatico incasso con 3 rubinetti di apertura/chiusura su piastra unica (3 uscite). Montaggio disponibile sia in verticale che orizzontale.

Built-in thermostatic mixer with 3 open/close taps on single plate (3 exits). Available mounting both vertically and horizontally.

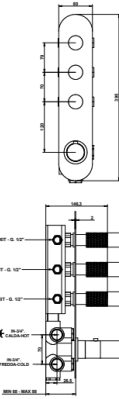

ARTICOLO COMPLETO / COMPLETE ITEM

88542CRGG03
CRGG/CRCC/CRGA

PARTE INCASSO
BUILT-IN PART

097300003

PARTE ESTERNA DA ABBINARE
EXTERNAL MATCHING PART

FINITURE / FINISHES

88542CRGG03EU
CRGG/CRCC/CRGA

88542PLGG03EU
PLGG/PLCC/PLGA/NSGG/
NSCC/NSGA

88542B1GG03EU *
B1GG/B1CC/B1GA/B2GG/
B2CC/B2GA/B3GG/B3CC/
B3GA/B4GG/B4CC/B4GA/
NEGG/NECC/NEGA/B1GG/
B1CC/B1GA/H0GG/H0CC/
H0GA/E0GG/E0CC/E0GA/
AUGG/AUCC/AUGA/M1GG/
M1CC/M1GA

88542ORGG03EU *
ORGG/ORCC/ORGA/CNCG/
CNCC/CNGA/OAOG/OACC/
OAGA

88542FAGG03EU *
FAGG/FACC/FAGA/APGG/
APCC/APGA/OPGG/OPCC/
OPGA

* Nelle varianti colore verniciate e satinato alcuni particolari saranno in finitura galvanica per garantire gli standard qualitativi. / To assure our quality standard on colored and satin product, some details remain in galvanic finishes.

Non disponibile in altre finiture. / Not available in other finishes.

Portata a pressione dinamica: 3 bar - 23 l/min. / Flow rates at dynamic pressure: 3 bar - 23 l/min.

Media portata. / Average water flow.

PROLUNGA / MIXER EXTENSION

00112CRPR03

00112XPR03 *

* Ricambio/prolunga per finiture diverse dal cromo. / Spare part/mixer extension for different finishes.

RICAMBI / SPARE PARTS

098450000 *

097940000 ◊

* Cartuccia miscelatrice / Mixer cartridge
◊ Vitone di apertura-chiusura / Open-close cartridge

FINITURE E COLORI / FINISHES AND COLOURS



MANIGLIE / HANDLES

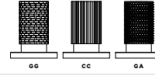

88542/4

Miscelatore termostatico incasso con 4 rubinetti di apertura/chiusura su piastra unica (4 uscite). Montaggio disponibile sia in verticale che orizzontale.

Built-in thermostatic mixer with 4 open/close taps on single plate (4 exits). Available mounting both vertically and horizontally.

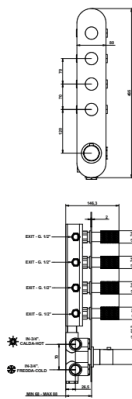

ARTICOLO COMPLETO / COMPLETE ITEM

88542CRGG04
CRGG/CRCC/CRGA

PARTE INCASSO
BUILT-IN PART

097300004

PARTE ESTERNA DA ABBINARE
EXTERNAL MATCHING PART

FINITURE / FINISHES

88542CRGG04EU
CRGG/CRCC/CRGA

88542PLGG04EU
PLGG/PLCC/PLGA/NSGG/
NSCC/NSGA

88542B1GG04EU
B1GG/B1CC/B1GA/B2GG/
B2CC/B2GA/B3GG/B3CC/
B3GA/B4GG/B4CC/B4GA/
NEGG/NECC/NEGA/B1GG/
B1CC/B1GA/H0GG/H0CC/
H0GA/E0GG/E0CC/E0GA/
AUGG/AUCC/AUGA/M1GG/
M1CC/M1GA

88542ORGG04EU *
ORGG/ORCC/ORGA/CNCG/
CNCC/CNGA/OAOG/OACC/
OAGA

88542FAGG04EU *
FAGG/FACC/FAGA/APGG/
APCC/APGA/OPGG/OPCC/
OPGA

* Nelle varianti colore verniciate e satinato alcuni particolari saranno in finitura galvanica per garantire gli standard qualitativi. / To assure our quality standard on colored and satin product, some details remain in galvanic finishes.

Non disponibile in altre finiture. / Not available in other finishes.

Portata a pressione dinamica: 3 bar - 23 l/min. / Flow rates at dynamic pressure: 3 bar - 23 l/min.

Media portata. / Average water flow.

PROLUNGA / MIXER EXTENSION

00112CRPR04

00112XPR04 *

* Ricambio/prolunga per finiture diverse dal cromo. / Spare part/mixer extension for different finishes.

RICAMBI / SPARE PARTS

098450000 *

097940000 ◊

* Cartuccia miscelatrice / Mixer cartridge
◊ Vitone di apertura-chiusura / Open-close cartridge

ACCESSORI E RICAMBI / ACCESSORIES AND SPARE PARTS



88 CAPSULE

MANIGLIE / HANDLES

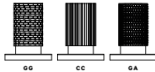

88642/2

Miscelatore termostatico incasso con 2 rubinetti di apertura/chiusura rotoni singoli (2 uscite). Built-in thermostatic mixer with 2 open/close taps single flange (2 exits).

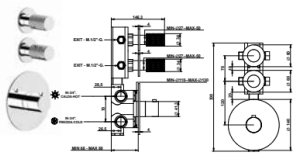

Portata a pressione dinamica: 3 bar - 23 l/min. / Flow rates at dynamic pressure: 3 bar - 23 l/min.

Media portata. / Average water flow

PROLUNGA / MIXER EXTENSION

00112CRPR02	00112XXPR02 *
-------------	---------------

* Ricambio/prolunga per finiture diverse dal cromo. / Spare part/mixer extension for different finishes

RICAMBI / SPARE PARTS

098450000 *	097940000 °
-------------	-------------

* Cartuccia miscelatrice / Mixer cartridge
° Vitone di apertura-chiusura / Open-close cartridge

88642/3

Miscelatore termostatico incasso con 3 rubinetti di apertura/chiusura rotoni singoli (3 uscite). Built-in thermostatic mixer with 3 open/close taps single flange (3 exits).

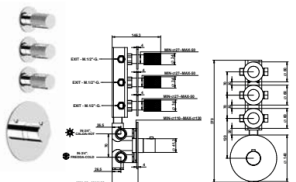

Portata a pressione dinamica: 3 bar - 23 l/min. / Flow rates at dynamic pressure: 3 bar - 23 l/min.

Media portata. / Average water flow.

PROLUNGA / MIXER EXTENSION

00112CRPR03	00112XXPR03 *
-------------	---------------

* Ricambio/prolunga per finiture diverse dal cromo. / Spare part/mixer extension for different finishes

RICAMBI / SPARE PARTS

098450000 *	097940000 °
-------------	-------------

* Cartuccia miscelatrice / Mixer cartridge
° Vitone di apertura-chiusura / Open-close cartridge

FINITURE E COLORI / FINISHES AND COLOURS



ARTICOLO COMPLETO / COMPLETE ITEM

88642CRGG02
CRGG/CRCC/CRGA

PARTE INCASSO
BUILT-IN PART

097300002

PARTE ESTERNA DA ABBINARE
EXTERNAL MATCHING PART

FINITURE / FINISHES

88642CRGG02EU
CRGG/CRCC/CRGA

88642PLGG02EU
PLGG/PLCC/PLGA/NSGG/
NSCC/NSGA

88642B1GG02EU
B1GG/B1CC/B1GA/B2GG/
B2CC/B2GA/B3GG/B3CC/
B3GA/B4GG/B4CC/B4GA/
NEG/NECC/NEGA/B1GG/
B1CC/B1GA/HOGG/HOCC/
HOGA/EOGG/EOCC/EOGA/
AUGG/AUCC/AUGA/MGG/
M1CC/M1GA

88642C2GG02EU
C2GG/C2CC/C2GA/C3GG/
C3CC/C3GA/C4GG/C4CC/
C4GA/ORG/ORCC/ORG/
CNGG/CNCC/CNGA/OAGG/
OAGC/OAGA

88642FAGG02EU
FAGG/FACC/FAGA/BMGG/
BMCC/BMGA/APGG/APCC/
APGA/OPGG/OPCC/OPGA

Non disponibile in altre finiture. / Not available in other finishes.

ARTICOLO COMPLETO / COMPLETE ITEM

88642CRGG03
CRGG/CRCC/CRGA

PARTE INCASSO
BUILT-IN PART

097300003

PARTE ESTERNA DA ABBINARE
EXTERNAL MATCHING PART

FINITURE / FINISHES

88642CRGG03EU
CRGG/CRCC/CRGA

88642PLGG03EU
PLGG/PLCC/PLGA/NSGG/
NSCC/NSGA

88642B1GG03EU
B1GG/B1CC/B1GA/B2GG/
B2CC/B2GA/B3GG/B3CC/
B3GA/B4GG/B4CC/B4GA/
NEG/NECC/NEGA/B1GG/
B1CC/B1GA/HOGG/HOCC/
HOGA/EOGG/EOCC/EOGA/
AUGG/AUCC/AUGA/MGG/
M1CC/M1GA

88642C2GG03EU *
C2GG/C2CC/C2GA/C3GG/
C3CC/C3GA/C4GG/C4CC/
C4GA/ORG/ORCC/ORG/
CNGG/CNCC/CNGA/OAGG/
OAGC/OAGA

88642FAGG03EU
FAGG/FACC/FAGA/BMGG/
BMCC/BMGA/APGG/APCC/
APGA/OPGG/OPCC/OPGA

* Nelle varianti colore verniciate e satinato alcuni particolari saranno in finitura galvanica per garantire gli standard qualitativi. / To assure our quality standard on colored and satin product, some details remain in galvanic finishes.

Non disponibile in altre finiture. / Not available in other finishes.

CAPSULE

MANIGLIE / HANDLES

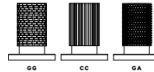

88642/4

Miscelatore termostatico incasso con 4 rubinetti di apertura/chiusura rotoni singoli (4 uscite). Built-in thermostatic mixer with 4 open/close taps single flange (4 exits).



* Nelle varianti colore verniciate e satinato alcuni particolari saranno in finitura galvanica per garantire gli standard qualitativi. / To assure our quality standard on colored and satin product, some details remain in galvanic finishes.

ARTICOLO COMPLETO / COMPLETE ITEM

88642CRGG04
CRGG/CRCC/CRGA

PARTE INCASSO
BUILT-IN PART

097300004

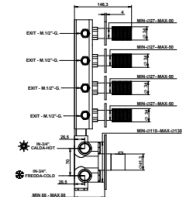
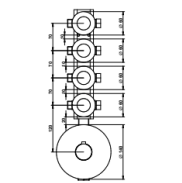

ACCESSORI E RICAMBI / ACCESSORIES AND SPARE PARTS



88 CAPSULE

MANIGLIE / HANDLES

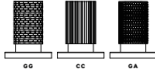

88523
Gruppo esterno per doccia External shower mixer

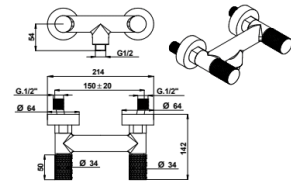

ARTICOLO COMPLETO / COMPLETE ITEM

88523CRGG
CRGG/CRCC/CRGA
88523PLGG
PLGG/PLCC/PLGA/NSGG/NSCC/NSGA
88523B1GG
B1GG/B1CC/B1GA/B2GG/B2CC/B2GA/B3GG/B3CC/
B3GA/B4GG/B4CC/B4GA/NEGG/NECC/NEGA/B1GG/
B1CC/B1GA/HOGG/HOCC/HOGA/EOGG/EOCC/
EOGA/AUGG/AUCC/AUGA/M1GG/M1CC/M1GA
88523ORGG
ORGG/ORCC/ORGA/CNCG/CNCC/CNGA/OAGG/
OACC/OAGA
88523FAGG
FAGG/FACC/FAGA/BMGG/BMCC/BMGA/APGG/
APCC/APGA/OPGG/OPCC/OPGA

Non disponibile in altre finiture. / Not available in other finishes.

ABBINABILE A / TO MATCH WITH:
Asta saliscendi / Sliding rail - 870

RICAMBI / SPARE PARTS

09790000 *	09790000 °
------------	------------

* Calda / Hot
° Fredda / Cold

88537/D

Gruppo doccia esterno con tubo, deviatore, soffione e set doccia. External shower mixer with tube, diverter, shower head and shower set.

Dettaglio flessibili / Flexible details General Catalogue 2023 pag. 36

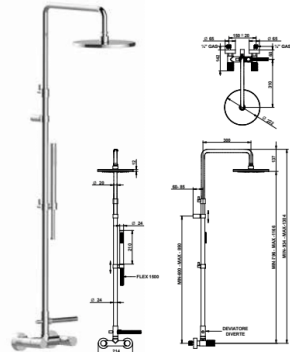

ARTICOLO COMPLETO / COMPLETE ITEM

88537CRGGD
CRGG/CRCC/CRGA
88537PLGGD
PLGG/PLCC/PLGA/NSGG/NSCC/NSGA
88537B1GGD
B1GG/B1CC/B1GA/B2GG/B2CC/B2GA/B3GG/B3CC/
B3GA/B4GG/B4CC/B4GA/NEGG/NECC/NEGA/B1GG/
B1CC/B1GA/HOGG/HOCC/HOGA/EOGG/EOCC/
EOGA/AUGG/AUCC/AUGA/M1GG/M1CC/M1GA
88537C2GGD
C2GG/C2CC/C2GA/C3GG/C3CC/C3GA/C4GG/C4CC/
C4GA/ORGG/ORCC/ORGA/CNCG/CNCC/CNGA/
OAGG/OACC/OAGA
88537FAGGD
FAGG/FACC/FAGA/BMGG/BMCC/BMGA/APGG/
APCC/APGA/OPGG/OPCC/OPGA

Non disponibile in altre finiture. / Not available in other finishes.

RICAMBI / SPARE PARTS

09790000 *	09790000 °
09600CR00	9600XXPV °
09600XX00 *	00850CR0E
00850XX00 °	00121CR00
00121XX00 °	08800CR00
00880XX00 *	

* Calda / Hot
° Fredda / Cold
* Per le finiture verniciate e satinato il flessibile verrà fornito in PVC nero. / The flexible will be supplied in black PVC for painted and matt finishes.
* Ricambio per finiture diverse dal cromo. / Spare part for different finishes.
* Ricambio per finiture galvaniche diverse dal cromo. / Spare part for galvanic finishes different from chrome.

FINITURE E COLORI / FINISHES AND COLOURS



CAPSULE

MANIGLIE / HANDLES

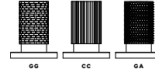

88431/SB
Gruppo bordo vasca quattro fori con set doccia senza bocca. Four holes deck bath and shower mixer with shower set without spout.

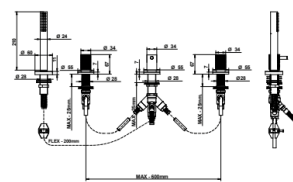

ARTICOLO COMPLETO / COMPLETE ITEM

88431CRGGSB
CRCC/CRCC/CRGA
88431PLGGSB
PLGG/PLCC/PLGA/NSGG/NSCC/NSGA
88431B1GGSB
B1GG/B1CC/B1GA/B2GG/B2CC/B2GA/B3GG/B3CC/
B3GA/B4GG/B4CC/B4GA/NEGG/NECC/NEGA/B1GG/
B1CC/B1GA/HOGG/HOCC/HOGA/EOGG/EOCC/
EOGA/AUGG/AUCC/AUGA/M1GG/M1CC/M1GA
88431C2GGSB
C2GG/C2CC/C2GA/C3GG/C3CC/C3GA/C4GG/C4CC/
C4GA/ORGG/ORCC/ORGA/CNCG/CNCC/CNGA/
OAGG/OACC/OAGA
88431FAGGSB
FAGG/FACC/FAGA/BMGG/BMCC/BMGA/APGG/
APCC/APGA/OPGG/OPCC/OPGA

Non disponibile in altre finiture. / Not available in other finishes.

ABBINABILE A / TO MATCH WITH:
Colonna scarico vasca con erogazione automatica. / Pop-up bath tube drain with water inlet - 680E3

RICAMBI / SPARE PARTS

09790000 *	09790000 °
09600CR00	09600XX00 °
00850CR0E	00850XX00 °
000121V00	

* Calda / Hot
° Fredda / Cold
° Ricambio per finiture diverse dal cromo. / Spare part for different finishes.

88536/D

Gruppo vasca esterno con set doccia. External bath and shower mixer with duplex shower set.

Dettaglio flessibili / Flexible details General Catalogue 2023 pag. 36

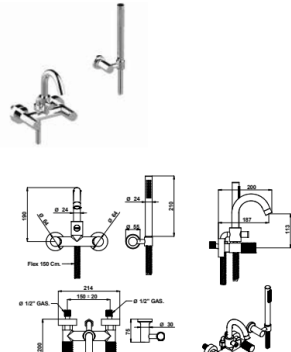

ARTICOLO COMPLETO / COMPLETE ITEM

88536CRGGD
CRGG/CRCC/CRGA
88536PLGGD
PLGG/PLCC/PLGA/NSGG/NSCC/NSGA
88536B1GGD
B1GG/B1CC/B1GA/B2GG/B2CC/B2GA/B3GG/B3CC/
B3GA/B4GG/B4CC/B4GA/NEGG/NECC/NEGA/B1GG/
B1CC/B1GA/HOGG/HOCC/HOGA/EOGG/EOCC/
EOGA/AUGG/AUCC/AUGA/M1GG/M1CC/M1GA
88536C2GGD
C2GG/C2CC/C2GA/C3GG/C3CC/C3GA/C4GG/C4CC/
C4GA/ORGG/ORCC/ORGA/CNCG/CNCC/CNGA/
OAGG/OACC/OAGA
88536FAGGD
FAGG/FACC/FAGA/BMGG/BMCC/BMGA/APGG/
APCC/APGA/OPGG/OPCC/OPGA

Non disponibile in altre finiture. / Not available in other finishes.

RICAMBI / SPARE PARTS

09790000 *	09790000 °
09996CR00	09996XX00 °
09600CR00	09600XXPV *
09600XX00 *	00850CR0E
00850XX00 °	00016CR00
00016XX00 °	

* Calda / Hot
° Fredda / Cold
* Ricambio per finiture diverse dal cromo. / Spare part for different finishes.
* Per le finiture verniciate e satinato il flessibile verrà fornito in PVC nero. / The flexible hose will be supplied in black PVC for painted and matt finishes.
* Ricambio per finiture galvaniche diverse dal cromo. / Spare part for galvanic finishes different from chrome.

ACCESSORI E RICAMBI / ACCESSORIES AND SPARE PARTS



88 CAPSULE

MANIGLIE / HANDLES

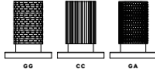

88534/D

Miscelatore vasca da pavimento con set doccia. Bath mixer to the floor with shower set.

Dettaglio flessibili / Flexible details General Catalogue 2022 pag. 36

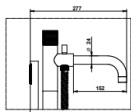

DETTAGLIO A

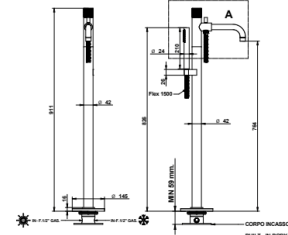

CORPO INCASSO

ARTICOLO COMPLETO / COMPLETE ITEM

88534CRGGDD
CRGG/CRCC/CRGA

PARTE INCASSO / BUILT-IN PART PARTE ESTERNA DA ABBINARE / EXTERNAL MATCHING PART

FINITURE / FINISHES

097440000

- 88534CRGGDEU CRGG/CRCC/CRGA
- 88534PLGGDEU * PLGG/PLCC/PLGA/NSGG/NSCC/NSGA
- 88534B1GGDEU B1GG/B1CC/B1GA/B2GG/B2CC/B2GA/B3GG/B3CC/B3GA/B4GG/B4CC/B4GA/NEGG/NECC/NEGA/B1GG/B1CC/B1GA/H0GG/H0CC/H0GA/H0GG/E0CC/E0GA/AUGG/AUCC/AUGA/M1GG/M1CC/M1GA
- 88534C2GGDEU C2GG/C2CC/C2GA/C3GG/C3CC/C3GA/C4GG/C4CC/C4GA/ORG/ORG/ORG/ORG/CN5G/CN5CC/CN5GA/ORG/ORG/DACC/OAGA
- 88534FAGGDEU FAGG/FACC/FAGA/BMGG/BMCC/BMGA/APGG/APCC/APGA/DPGG/DPCC/DPGA

* Nelle varianti colore verniciate e satinato alcuni particolari saranno in finitura galvanica per garantire gli standard qualitativi. / To assure our quality standard on colored and satin product, some details remain in galvanic finishes.

Non disponibile in altre finiture. / Not available in other finishes.

RICAMBI / SPARE PARTS

09850000	0999CR00
0999EX00 *	09811CR00
09600XPV ⁽¹⁾	09600XX00 ⁽¹⁾
09800CROE	00850XX00 *
00139CR00	00139XX00 *

* Ricambio per finiture diverse dal cromo. / Spare part for different finishes.
⁽¹⁾ Per le finiture verniciate e satinato il flessibile verrà fornito in PVC nero. / The flexible hose will be supplied in black PVC for painted and matt finishes.
 * Ricambio per finiture galvaniche diverse dal cromo. / Spare part for galvanic finishes different from chrome.

FINITURE E COLORI / FINISHES AND COLOURS



CAPSULE

MANIGLIE / HANDLES

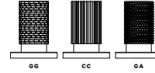

996/70

Bocca vasca a pavimento 700mm. Floor mounted bath spout 700 mm.

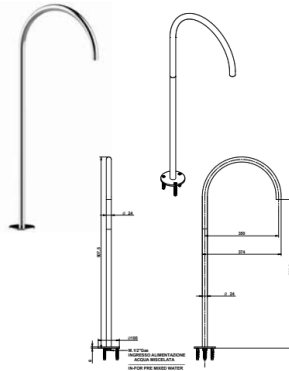

ARTICOLO COMPLETO / COMPLETE ITEM

0996CR70
CR

0996PL70
PL/NS

0996B170
B1/B2/B3/B4/NE/BU/HQ/EQ/AU/MI

0996C270
C2/C3/C4/OR/CN/OA/BM/AP/OP

Non disponibile in altre finiture. / Not available in other finishes.

RICAMBI / SPARE PARTS

0937900VA

996/100

Bocca lavabo a pavimento 1000 mm. Floor mounted basin spout 1000 mm.

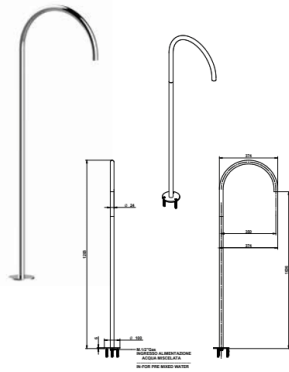

ARTICOLO COMPLETO / COMPLETE ITEM

0996CR100
CR

0996PL100
PL/NS

0996B1100
B1/B2/B3/B4/NE/BU/HQ/EQ/AU/MI

0996C2100
C2/C3/C4/OR/CN/OA/OP/BM/AP

Non disponibile in altre finiture. / Not available in other finishes.

ABBINABILE A / TO MATCH WITH:
Sifone / Siphon - 00087

Piattaia clic-clic / Clic-clic waste - 00079

RICAMBI / SPARE PARTS

093790000

ACCESSORI E RICAMBI / ACCESSORIES AND SPARE PARTS



88 CAPSULE

MANIGLIE / HANDLES

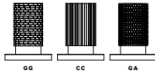

01023
Bocca lavabo 3 fori. Basin spout 3 holes.



ARTICOLO COMPLETO / COMPLETE ITEM
01023CR00 CR
01023PL00 PL/NS
01023B100 B1/B2/B3/B4/NE/BI/HO/EO/AU/MI
01023C200 C2/C3/C4/OR/CN/OA
01023FA00 FA/BM/AP/OP
 Non disponibile in altre finiture. / Not available in other finishes.

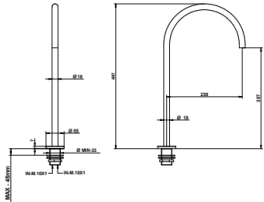

RICAMBI / SPARE PARTS
093920000

01023/H
Bocca lavabo alta 3 fori. High basin spout 3 holes.



ARTICOLO COMPLETO / COMPLETE ITEM
01023CR0H CR
01023PL0H PL/NS
01023B10H B1/B2/B3/B4/NE/BI/HO/EO/AU/MI
01023C20H C2/C3/C4/OR/CN/OA
01023FA0H FA/BM/AP/OP
 Non disponibile in altre finiture. / Not available in other finishes.

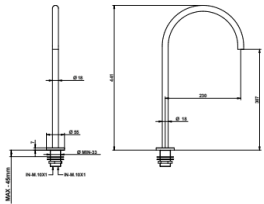

RICAMBI / SPARE PARTS
093920000

FINITURE E COLORI / FINISHES AND COLOURS



banco

CAPSULE

MANIGLIE / HANDLES

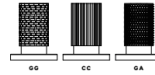

01024
Bocca lavabo per miscelatore. Basin spout for mixer.



ARTICOLO COMPLETO / COMPLETE ITEM
01024CR00 CR
01024PL00 PL/NS
01024B100 B1/B2/B3/B4/NE/BI/HO/EO/AU/MI
01024C200 C2/C3/C4/OR/CN/OA
01024FA00 FA/BM/AP/OP
 Non disponibile in altre finiture. / Not available in other finishes.

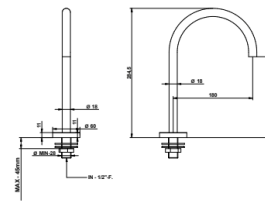

RICAMBI / SPARE PARTS
093920000

01024/H
Bocca lavabo alta per miscelatore. High basin spout for mixer.



ARTICOLO COMPLETO / COMPLETE ITEM
01024CR0H CR
01024PL0H PL/NS
01024B10H B1/B2/B3/B4/NE/BI/HO/EO/AU/MI
01024C20H C2/C3/C4/OR/CN/OA
01024FA0H FA/BM/AP/OP
 Non disponibile in altre finiture. / Not available in other finishes.

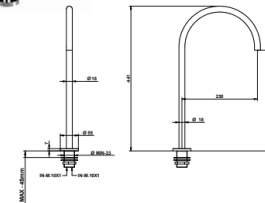

RICAMBI / SPARE PARTS
093920000

ACCESSORI E RICAMBI / ACCESSORIES AND SPARE PARTS



88 CAPSULE

MANIGLIE / HANDLES

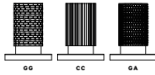

01021

Bocca incasso Ø 18 mm, 229 mm. Lunghezza 1/2" M.

Built-in spout Ø 18 mm, 229 mm. Long 1/2" M.

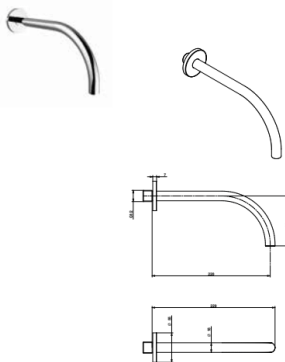

ARTICOLO COMPLETO / COMPLETE ITEM

- 01021R00 CR
- 01021P00 PL/NS
- 01021B100 B1/B2/B3/B4/NE/BI/HO/EO/AU/MI
- 01021G200 C2/C3/CA/OR/CN/OA
- 01021EA00 FA/BM/AP/OP

Non disponibile in altre finiture. / Not available in other finishes.

RICAMBI / SPARE PARTS



093920000

01021/75

Bocca incasso Ø 18 mm, 229 mm. Lunghezza 1/2" M. Rosone Ø 75 mm.

Built-in spout Ø 18 mm, 229 mm. Long 1/2" M. Ø 75 mm flange.

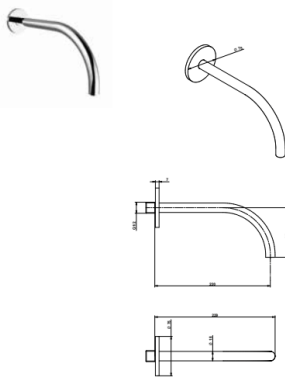

ARTICOLO COMPLETO / COMPLETE ITEM

- 01021CR75 CR
- 01021PL75 PL/NS
- 01021B175 B1/B2/B3/B4/NE/BI/HO/EO/AU/MI
- 01021G275 C2/C3/CA/OR/CN/OA
- 01021EA75 FA/BM/AP/OP

Non disponibile in altre finiture. / Not available in other finishes.

RICAMBI / SPARE PARTS



093920000

FINITURE E COLORI / FINISHES AND COLOURS



bonpo

CAPSULE

MANIGLIE / HANDLES

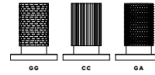

01017/19

Bocca incasso Ø 21 mm, 190 mm. Lunghezza 1/2" M.

Built-in spout Ø 21 mm, 190 mm. Long 1/2" M.

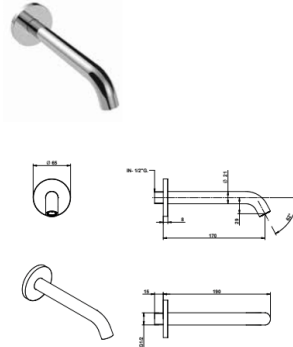

ARTICOLO COMPLETO / COMPLETE ITEM

- 01017CR19 CR
- 01017B119 B1/B2/B3/B4/AU/EO/HO/MI/NE/BI/NS
- 01017C219 C2/C3/CA/OR/OP/PL/BM/OA
- 01017EA19 FA/BM/AP
- 01017XX19 * XX

* XX: Per tutte le altre finiture fattibili riferirsi a questa fascia di prezzo. / Refer to this line of price for all other realizable finishes.

RICAMBI / SPARE PARTS



093900000

88830

Duplex con erogazione, supporto fisso, doccetta monogetto e flessibile mm 1500, 1/2" FF conico.

Brass shower set with water supply elbow, fixed bracket, single function handshower and 1500 mm, 1/2" FF conical.

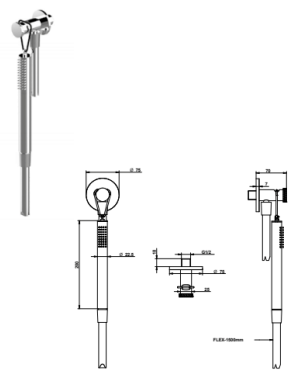

ARTICOLO COMPLETO / COMPLETE ITEM

- 88830CRGG CRGG/CRCC/CRGA
- 88830PLGG PLGG/PLCC/PLGA/NSGG/NSCC/NSGA
- 88830B100 B1GG/B1CC/B1GA/B2GG/B2CC/B2GA/B3GG/B3CC/B3GA/B4GG/B4CC/B4GA/NEGG/NECC/NEGA/BI00/BI0C/BI0A/HD00/HD0C/HD0A/EOGG/EOCC/EOGA/AU00/AU0C/AU0A/MISG/MISCC/MISGA
- 88830C200 C2GG/C2CC/C2GA/C3GG/C3CC/C3GA/C4GG/C4CC/C4GA/OR00/OR0C/OR0A/CN00/CN0C/CN0A/OAGG/OACC/OAGA
- 88830FAGG FAGG/FACC/FAGA/BMGG/BMCC/BMGA/APGG/APCC/APAA/OPGG/OPCCA/OPGA

Sistema antiscorie Fast Clean. Pressione dinamica minima di utilizzo 1 bar. Portata a pressione dinamica 1-5 bar - 5 l/min. / Fast Clean shower. Minimum dynamic pressure of use 1 bar. Flow rates at dynamic pressure 1-5 bar - 5 l/min.

Non disponibile in altre finiture. / Not available in other finishes.

RICAMBI / SPARE PARTS

	009600CR0000		09600XPV00 *
	009600XX0000 †		88850CR0000
	88850XX0000 †		88850CU000

* Per le finiture verniciate e satinato il flessibile verrà fornito in PVC nero. / The flexible hose will be supplied in black PVC for painted and matt finishes.
 † Ricambio per finiture galvaniche diverse dal cromo. / Spare part for galvanic finishes different from chrome.
 ‡ Ricambio per finiture diverse dal cromo. / Spare part for different finishes.

ACCESSORI E RICAMBI / ACCESSORIES AND SPARE PARTS



88 CAPSULE

MANIGLIE / HANDLES

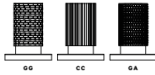

880

Soffione doccia tondo Ø 222 mm ispezionabile.

Ø 222 mms round shower head inspectable.

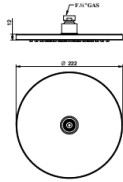

ARTICOLO COMPLETO / COMPLETE ITEM

- 00880CR00 CR
- 00880B100 BU/B2/B3/B4/AU/EO/HO/MI/NS/NE/PL/BI
- 00880C200 C2/C3/C4/OA/FA/OR/BM
- 00880AP00 AP/CN/FA/OP
- 00880XX00* XX

*XX: Per tutte le altre finiture fattibili riferirsi a questa fascia di prezzo. / Refer to this line of price for all other realizable finishes.

Systema anticalcare Fast Clean. Pressione dinamica minima di utilizzo 1 bar. Portata a pressione dinamica con limitatore 1/5 bar - 8 l/min. / Fast Clean shower. Minimum dynamic pressure of use 1 bar. Flow rates at dynamic pressure: with limitation system 1/5 bar - 8 l/min.

882

Soffione doccia tondo a 300 mm spessore 7,5 mm. ispezionabile per manutenzione.

Ø 300 mms. round shower head, 7,5 mms. thick. inspectable for maintenance.

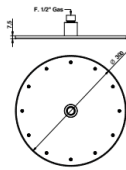

ARTICOLO COMPLETO / COMPLETE ITEM

- 00882CR00 CR
- 00882NS00 NS
- 00882B100 BU/B2/B3/B4/AU/EO/HO/MI/NE/BU/PL
- 00882C200 C2/C3/C4/OA/OR/FA/BM
- 00882AP00 AP/CN/FA/OP
- 00882XX00* XX

*XX: Per tutte le altre finiture fattibili riferirsi a questa fascia di prezzo. / Refer to this line of price for all other realizable finishes.

Systema anticalcare Fast Clean. Pressione dinamica minima di utilizzo 1 bar. Portata a pressione dinamica con limitatore 1/5 bar - 14 l/min. / Fast Clean shower. Minimum dynamic pressure of use 1 bar. Flow rates at dynamic pressure: with limitation system 1/5 bar - 14 l/min.

FINITURE E COLORI / FINISHES AND COLOURS



banqo

CAPSULE

MANIGLIE / HANDLES

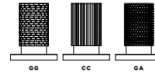

804/30PR

Braccio doccia soffitto da 300 mm. Mms. 300 ceiling shower arm.

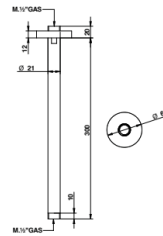

ARTICOLO COMPLETO / COMPLETE ITEM

- 00804CR30PR CR
- 00804B30PR BU/B2/B3/B4/AU/EO/HO/MI/NS/NE/BI
- 00804PL30PR PL/BM
- 00804C230PR C2/C3/C4/OA/OR
- 00804AP30PR AP/CN/FA/OP
- 00804XX30PR* XX

*XX: Per tutte le altre finiture fattibili riferirsi a questa fascia di prezzo. / Refer to this line of price for all other realizable finishes.

Disponibile anche nella misura da 150 mm. / 150 mms. available.

802/35PR

Braccio doccia 350 mm. Mms. 350 shower arm.

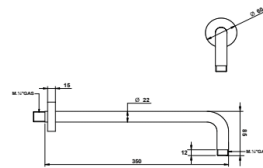

ARTICOLO COMPLETO / COMPLETE ITEM

- 00802CR35PR CR
- 00802AU35PR AU/EO/HO/MI/NS/NE/BI
- 00802B35PR BU/B2/B3/B4/PL/BM
- 00802C235PR C2/C3/C4/OA/OR
- 00802AP35PR AP/CN/FA/OP
- 00802XX35PR* XX

*XX: Per tutte le altre finiture fattibili riferirsi a questa fascia di prezzo. / Refer to this line of price for all other realizable finishes.

Disponibile anche nella misura da 300 mm e da 400 mm. / 300 mms. and 400 mms. available.

ACCESSORI E RICAMBI / ACCESSORIES AND SPARE PARTS



88 CAPSULE

MANIGLIE / HANDLES

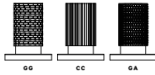

904

Set doccia bidet a muro tondo per wc con presa acqua e rubinetto apriti-chiudi. Round bidet shower set for wc with water supply elbow and open-close tap.

Dettaglio flessibili / Flexible details General Catalogue 2023 pag. 36

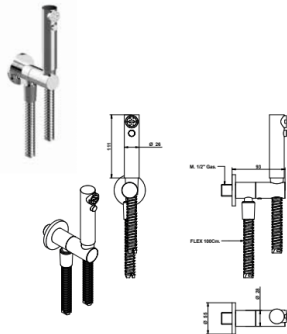

ARTICOLO COMPLETO / COMPLETE ITEM

00904CR00
CR
00904AU00 *
AU/EO/HO/MI/NS/NE/BI
00904C200 *
C2/C3/C4/OR/OA
00904AP00 *
AP/BM/FA/OP/CN
00904XX00 *
XX

* Nelle varianti colore verniciate o satinato alcuni particolari saranno in finitura galvanica per garantire gli standard qualitativi. / To assure our quality standard on colored and satin product, some details remain in galvanic finishes.

** XX: Per tutte le altre finiture fattibili riferirsi a questa fascia di prezzo. / Refer to this line of price for all other realizable finishes.

ABBINABILE A / TO MATCH WITH:
Miscelatore incasso / Built-in mixer - 524

RICAMBI / SPARE PARTS

	00904V121 *		09605CRPV
	09605XPV *		09610XX00 *
	00904CRD0		00904XXD0 *

* Da Settembre 2021 / From September 2021
* Per le finiture verniciate e satinato il flessibile verrà fornito in PVC nero. / The flexible hose will be supplied in black PVC for painted and matt finishes.
* Ricambio per finiture galvaniche diverse dal cromo. / Spare part for galvanic finishes different from chrome.
* Ricambio per finiture diverse dal cromo. / Spare part for different finishes.

904/ID

Set idroscopio a muro tondo per wc con presa acqua e rubinetto apriti-chiudi. Round hydrobrushes toilet set for wc with water supply elbow and open-close tap.

Dettaglio flessibili / Flexible details General Catalogue 2023 pag. 36

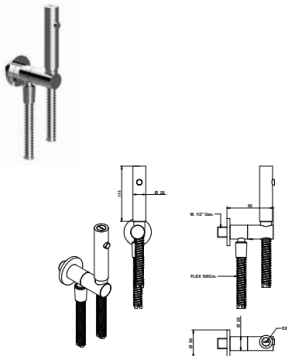

ARTICOLO COMPLETO / COMPLETE ITEM

00904CRID
CR
00904AUID *
AU/EO/HO/MI/NS/NE/BI
00904C2ID *
C2/C3/C4/OR/OA
00904APID *
AP/BM/FA/OP/CN
00904XXID *
XX

* Nelle varianti colore verniciate e satinato alcuni particolari saranno in finitura galvanica per garantire gli standard qualitativi. / To assure our quality standard on colored and satin product, some details remain in galvanic finishes.

** XX: Per tutte le altre finiture fattibili riferirsi a questa fascia di prezzo. / Refer to this line of price for all other realizable finishes.

RICAMBI / SPARE PARTS

	00904V121 *		09605CRPV
	09605XPV *		09610XX00 *
	00904CRDI		00904XXDI *

* Da Settembre 2021 / From September 2021
* Per le finiture verniciate e satinato il flessibile verrà fornito in PVC nero. / The flexible hose will be supplied in black PVC for painted and matt finishes.
* Ricambio per finiture galvaniche diverse dal cromo. / Spare part for galvanic finishes different from chrome.
* Ricambio per finiture diverse dal cromo. / Spare part for different finishes.

FINITURE E COLORI / FINISHES AND COLOURS



bonpo

CAPSULE

MANIGLIE / HANDLES

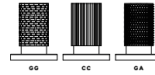

44034

Placca di comando cassetta wc di design con fissaggio a scomparsa, in ottone compatibile con cassetta da incasso Geberit: SIGMA/8 - SIGMA 12

Brass toilet flush control plate with no visible fixing, compatible with Geberit built-in system SIGMA/8 - SIGMA 12

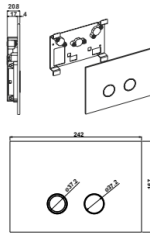

ARTICOLO COMPLETO / COMPLETE ITEM

44034CR00
CR
44034B100
BI/NE
44034B100
B1/B2/B3/B4/AU/EO/HO/MI/NS
44034C200
C2/C3/C4/OA/AP/OR/FA/BM
44034XX00 *
XX

* XX: Per tutte le altre finiture fattibili riferirsi a questa fascia di prezzo. / Refer to this line of price for all other realizable finishes.

44035

Placca di comando cassetta wc di design con fissaggio a scomparsa, in ottone compatibile TECE 9370007.

Brass desing toilet flush control plate with no visible fixing, compatible with TECE built-in system 9370007.

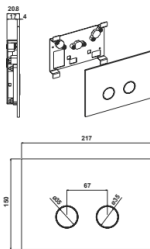

ARTICOLO COMPLETO / COMPLETE ITEM

44035CR00
CR
44035NE00
NE/BI
44035AU00
AU/EO/HO/MI/NS
44035C200
C2/C3/C4/OA/AP/OR/FA/BM
44035XX00 *
XX

* XX: Per tutte le altre finiture fattibili riferirsi a questa fascia di prezzo. / Refer to this line of price for all other realizable finishes.

ACCESSORI E RICAMBI / ACCESSORIES AND SPARE PARTS



88 CAPSULE

MANIGLIE / HANDLES

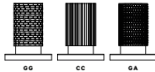

bonpo

88001
Porta abito. Robe hook.

ARTICOLO COMPLETO / COMPLETE ITEM

88001CRGG
CRGG/CRCC/CRGA

88001PLGG
PLGG/PLCC/PLGA/NSGG/NSCC/NSGA

88001B1GG
B1GG/B1CC/B1GA/B2GG/B2CC/B2GA/B3GG/B3CC/
B3GA/B4GG/B4CC/B4GA/NEGG/NECC/NEGA/B1GG/
B1CC/B1GA/HOGG/HOCC/HOGA/EOGG/EOCC/
EOGA/AUGG/AUCC/AUGA/M1GG/M1CC/M1GA

88001C2GG
C2GG/C2CC/C2GA/C3GG/C3CC/C3GA/C4GG/C4CC/
C4GA/ORGG/ORCC/ORGA/CNCG/CNCC/CNGA/
OAGG/OACC/OAGA

88001FAGG
FAGG/FACC/FAGA/BMGG/BMCC/BMGA/APGG/
APCC/APGA/OPGG/OPCC/OPGA

Non disponibile in altre finiture. / Not available in other finishes.

88009
Porta rotolo. Toilet paper holder.

ARTICOLO COMPLETO / COMPLETE ITEM

88009CRGG
CRGG/CRCC/CRGA

88009PLGG
PLGG/PLCC/PLGA/NSGG/NSCC/NSGA

88009B1GG
B1GG/B1CC/B1GA/B2GG/B2CC/B2GA/B3GG/B3CC/
B3GA/B4GG/B4CC/B4GA/NEGG/NECC/NEGA/B1GG/
B1CC/B1GA/HOGG/HOCC/HOGA/EOGG/EOCC/
EOGA/AUGG/AUCC/AUGA/M1GG/M1CC/M1GA

88009C2GG
C2GG/C2CC/C2GA/C3GG/C3CC/C3GA/C4GG/C4CC/
C4GA/ORGG/ORCC/ORGA/CNCG/CNCC/CNGA/
OAGG/OACC/OAGA

88009FAGG
FAGG/FACC/FAGA/BMGG/BMCC/BMGA/APGG/
APCC/APGA/OPGG/OPCC/OPGA

Non disponibile in altre finiture. / Not available in other finishes.

88007/60
Porta asciugamano 600 mm. 600 mm. towel rail.

ARTICOLO COMPLETO / COMPLETE ITEM

88007CRGG60
CRGG/CRCC/CRGA

88007PLGG60
PLGG/PLCC/PLGA/NSGG/NSCC/NSGA

88007B1GG60
B1GG/B1CC/B1GA/B2GG/B2CC/B2GA/B3GG/B3CC/
B3GA/B4GG/B4CC/B4GA/NEGG/NECC/NEGA/B1GG/
B1CC/B1GA/HOGG/HOCC/HOGA/EOGG/EOCC/
EOGA/AUGG/AUCC/AUGA/M1GG/M1CC/M1GA

88007ORGG60
ORGG/ORCC/ORGA/CNCG/CNCC/CNGA/OAGG/
OACC/OAGA

88007FAGG60
FAGG/FACC/FAGA/BMGG/BMCC/BMGA/APGG/
APCC/APGA/OPGG/OPCC/OPGA

Non disponibile in altre finiture. / Not available in other finishes.

FINITURE E COLORI / FINISHES AND COLOURS



CAPSULE

MANIGLIE / HANDLES

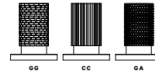

30022
Porta bicchiere appoggio. Glass holder to lean.

ARTICOLO COMPLETO / COMPLETE ITEM

30022CR00
CR

30022NE00
NE/NS/BI

30022B100
B1/B2/B3/B4/AU/EO/HO/MI/OR

30022C200
C2/C3/CA/AP/DA/BM

30022XX00 *
XX

*XX: Per tutte le altre finiture fattibili riferirsi a questa fascia di prezzo. / Refer to this line of price for all other realizable finishes.

RICAMBI / SPARE PARTS

306970000

30027
Porta dispenser appoggio. Soap dispenser to lean.

ARTICOLO COMPLETO / COMPLETE ITEM

30027CR00
CR

30027B100
BI/NE/NS

30027B100
B1/B2/B3/B4/AU/EO/HO/MI/OR

30027C200
C2/C3/CA/AP/DA/BM

30027XX00 *
XX

*XX: Per tutte le altre finiture fattibili riferirsi a questa fascia di prezzo. / Refer to this line of price for all other realizable finishes.

RICAMBI / SPARE PARTS

30698CR00 30698XX00 *

*Ricambio per finiture diverse dal cromo. / Spare part for different finishes.

30025
Porta scopino appoggio con base in ABS antigraffio. Toilet brush holder to lean with scratchproof ABS base.

ARTICOLO COMPLETO / COMPLETE ITEM

30025CR00
CR

30025B100
BI/NE/NS

30025C200
C2/C3/CA/AP/DA/OR

30025XX00 *
XX

*XX: Per tutte le altre finiture fattibili riferirsi a questa fascia di prezzo. / Refer to this line of price for all other realizable finishes.

RICAMBI / SPARE PARTS

30720
Nero / Black

ACCESSORI E RICAMBI / ACCESSORIES AND SPARE PARTS



CONDIZIONI GENERALI DI VENDITA

Le presenti condizioni generali disciplinano tutti gli attuali e futuri contratti fra le parti, salvo eventuali deroghe concordate per iscritto. Le condizioni generali del compratore non trovano applicazione nei rapporti futuri tra le parti se non espressamente accettate per iscritto dalla Mario Bongio S.r.l.

1. Applicazione del contratto

L'invio da parte del compratore di un ordine al venditore comporta l'applicazione al contratto di vendita delle presenti condizioni generali. Il venditore si riserva il diritto di accettare o rifiutare l'ordine ricevuto. Le offerte stipulate da agenti, rappresentanti ed ausiliari del commercio del venditore al compratore, non sono impegnative fino a quando non siano confermate da sede centrale del venditore stesso.

2. Prezzi

I prezzi indicati nei listini Mario Bongio S.r.l. sono in euro e sono da intendersi esclusi di costi di trasporto, assicurazione ed iva. Ai prezzi deve essere applicata l'aliquota in vigore al momento della fatturazione. Il venditore si riserva di modificare i prezzi e/o variare il listino prezzi senza alcun preavviso.

3. Resa della merce

Salvo patto contrario, la fornitura dei prodotti si intende Franco Fabbrica del venditore ed assicurazione sono pertanto a carico del compratore ed i rischi relativi al trasporto della fornitura passano al compratore nel momento in cui i prodotti lasciano lo stabilimento del venditore. Nel caso il venditore agisse come mandatario del compratore, il trasporto verrà effettuato a rischio del compratore.

4. Termini di consegna

I termini di consegna indicati sulle conferme d'ordine non sono tassativi e, in nessun caso, possono giustificare ritardi nei pagamenti o dare luogo a risarcimento di danni e/o contestazioni. È esclusa qualsiasi responsabilità del venditore per danni derivanti da anticipata, ritardata o mancata consegna, totale o parziale. Il compratore è sempre tenuto a prendere in consegna i prodotti, anche in caso di consegne parziali e quando i contratti vengano consegnati prima o successivamente alla data di consegna stabilita. Il termine di consegna verrà prorogato di un periodo pari a quello della durata dell'impedimento al verificarsi di cause di forza maggiore. In nessun caso, a causa del verificarsi di tali circostanze, il compratore potrà esigere compensi o indennizzi di qualsiasi natura.

5. Garanzia

Il venditore garantisce la conformità dei prodotti forniti. Con termine di conformità dei prodotti si intende che essi corrispondono per qualità, quantità e tipo a quanto stabilito nel contratto e che sono esenti da vizi che potrebbero renderli non idonei all'uso cui sono destinati. La garanzia è limitata ai soli difetti dei prodotti conseguenti a difetti di progettazione, di produzione, di materiale o di costruzione, riconducibili al venditore, e non si applica nel caso in cui il compratore non abbia effettuato una corretta conservazione/manutenzione dei prodotti e/o li abbia modificati senza il consenso del venditore. Il venditore non risponde dei difetti dovuti all'usura di quelle parti che, per loro natura sono soggette a usura rapida e continua. Per ogni altra precisazione si rimanda al libretto di garanzia generale Mario Bongio S.r.l.

6. Reclami

Il compratore è tenuto a verificare la conformità dei prodotti e l'assenza di vizi entro otto giorni dalla data di ricevimento delle merci. I reclami relativi a non conformità dei prodotti forniti dovranno essere pertanto effettuati, a pena di decadenza, entro e non oltre otto giorni dal ricevimento della merce. Tutti i reclami devono essere inviati al venditore, per iscritto, via mail e devono riportare nel dettaglio i vizi e le non conformità contestate. In caso di reclamo effettuato nei termini e nei modi sopra indicati, la merce dovrà essere tenuta integralmente a disposizione del venditore per i controlli che lo stesso riterrà opportuni.

7. Rimedi

In caso di prodotti non conformi e, dopo aver ricevuto un rapporto dettagliato dal compratore, il venditore potrà, a sua insindacabile scelta: a) fornire gratuitamente Franco Fabbrica al compratore prodotti dello stesso genere e quantità di quelli risultanti difettosi o non conformi a quanto pattuito, dopo averne ottenuto la resa per la verifica. L'eventuale sostituzione effettuata prontamente dal venditore non può essere ritenuta un implicito riconoscimento dei vizi contestati. Qualora il venditore, in sede di verifica, non riconosca viziati i prodotti, provvederà alla

fatturazione di quelli inviati in sostituzione;

b) emettere una nota di accredito a favore del compratore per un importo corrispondente al valore dei prodotti difettosi. In entrambi i casi il venditore ha diritto alla restituzione dei prodotti difettosi, che diventano di sua proprietà.

8. Resi

I resi di merce da parte del compratore dovranno sempre comunque essere autorizzati per iscritto dalla nostra sede. I resi preventivamente autorizzati devono giungere al venditore franco magazzino di San Maurizio d'Oglio in buon ordine e negli imballaggi originali. L'accredito per le merci rese, sarà stilato ad avvenuta presa in carico del nostro magazzino e relativo controllo. Danni ai prodotti ed agli imballaggi saranno dettati dall'accredito medesimo.

9. Pagamento

I pagamenti ed ogni altra somma dovuta a qualsiasi titolo al venditore, si intendono netti al suo domicilio. I pagamenti dovranno essere effettuati nei termini stabiliti anche in caso di ritardo nella consegna, oppure di perdita totale / parziale della merce non imputabile al venditore. Qualsiasi ritardo o irregolarità nel pagamento, concede al venditore il diritto di sospendere le forniture successive e/o future e di risolvere eventuali contratti in corso, anche non direttamente relativi ai pagamenti in questione, nonché il diritto al risarcimento degli eventuali danni. Il venditore ha altresì il diritto, a decorrere dalla scadenza del pagamento, agli interessi moratori nella misura stabilita in Italia dall'art. 5 del Decreto Legislativo 9 ottobre 2002 n. 231 ed il diritto di escludere la garanzia sul prodotto. Il cliente non ha diritto di effettuare trattative a compensazione sui pagamenti, anche in caso siano in essere contestazioni e/o ritardare qualsiasi altro pagamento dovuto.

10. Riserva di proprietà

I prodotti consegnati restano di proprietà del venditore sino al momento del completo pagamento del prezzo.

11. Legge applicabile e foro competente

Tutti i contratti disciplinati dalle presenti condizioni generali sono regolati dalla legge italiana. Per ogni controversia relativa o comunque collegata a contratti cui si applicano le presenti condizioni generali è esclusivamente competente il foro del tribunale di Novara.

12. Importo minimo ordini

MERCATO NAZIONALE ITALIA
Per ordini inferiori a € 250,00 viene richiesto un contributo spese amministrative di € 20,00.
Il minimo valore d'ordine per porto franco è € 600,00.

MERCATO UE

Per ordini inferiori a € 250,00 viene richiesto un contributo spese amministrative di € 20,00.
Il minimo valore d'ordine per porto franco è € 800,00.

MERCATO EXTRA-UE

Per ordini inferiori a € 250,00 viene richiesto un contributo spese amministrative di € 40,00.
Eventuali verifiche di origine o altri, verranno qualificati a parte. Il minimo valore d'ordine per porto franco è € 1500,00.

13. Cataloghi cartacei e digitali

Le illustrazioni dei prodotti sono una rappresentazione di ogni articolo, ma non costituiscono impegno di fedele esecuzione. In particolare, l'indicazione delle tonalità di colore/finiture delle fotografie, cataloghi e/o eventuali campioni deve considerarsi puramente indicativa e, quindi, eventuali differenze cromatiche non possono essere denunciate come vizio. In quanto non modificative delle qualità essenziali del prodotto. L'azienda si riserva il diritto di effettuare modifiche sia tecniche che estetiche senza preavviso, come pure procedere alla eliminazione di singoli articoli o di serie complete.

14. Accettazione Condizioni

L'avvenuta esecuzione del contratto con il ritiro della merce da parte del cliente è considerata quale tacita accettazione delle presenti condizioni.

Il presente catalogo annulla e sostituisce i precedenti.

Le informazioni in esso contenute possono subire variazioni senza alcun preavviso.

GENERAL SALE CONDITIONS

These general sale conditions of sale regulate all current and future contracts between the parties, except for any further derogation agreed in writing. Any general conditions of the buyer will not be applied in the future cooperation between the parties, unless expressly accepted in writing by Mario Bongio S.r.l.

1. Application of the Contract

The buyer, placing the order, fully accepts automatically the application of these general terms. The Seller reserves the right to accept or refuse the order of the buyer. Offers made by agents, representatives or auxiliaries of the seller to the buyer, are not binding until they are confirmed directly by the seller itself.

2. Prices

The prices indicated in the Mario Bongio S.r.l. price lists are in Euro currency and they do not include shipment costs, VAT or any other tax. The Seller has the right to amend the prices/price list without any prior notice.

3. Delivery of the goods

Unless otherwise agreed in writing, the supply of the products has to be considered ex-factory (ex-works) San Maurizio d'Oglio unloaded at customs: transport and insurance costs are therefore at buyer account and all the risks relative to the transportation and/or handling of the products are responsibility of the buyer in the moment the products leave the warehouse of the seller. In the case the seller will act as the buyer's agent, transport, insurance costs and all the risks will be again at buyer account.

4. Delivery time of the goods

The delivery time indicated on the order confirmation is not preteremptory and it cannot be justification for delays in payments or claims for damages. Any liability of the seller has excluded from any damages coming from anticipated, delayed or non-delivery, total or partial of the goods. The buyer is always required to accept the delivery of the products, even in the case of partial deliveries and when the products have been delivered before the established delivery date or successively to that date. The delivery time will be extended accordingly at the occurrence of causes of force majeure. In any case, due to the occurrence of such circumstances, the buyer may demand any compensation or refund.

5. Guarantee

The seller guarantees the compliance of the products supplied; the term "compliance of the products" means the products correspond in quality, quantity and type, to what has been agreed in the contract and that they are without defects, that could prevent use for which they are intended to be. The guarantee against defects has limited only to production defects that can be attributed to the seller and it does not apply in the case where the buyer is unable to prove a correct preservation of the product and where he has modified and/or handled them without the agreement of the seller. The seller is not liable for defects due to the wear and tear of those parts which by their nature are subject to a rapid and continuous wear and tear. For any further details relative to the Warranty, please go through the general Mario Bongio S.r.l. warranty book.

6. Claims

The purchaser has to control the compliance of the products and the absence of flaws within eight days from receipt of the material. Claims relevant to non-conformities of the goods must be communicated, on pain of forfeiture, within and not later than eight days from receipt of the material at their place of destination. Claims must be sent by written note to the seller and must be well detailed. In case of a claim, regularly effected as specified above, the material should be taken at disposal of the seller for the necessary controls.

7. Resolution of the Claims

In case of faulty products and after receiving a detailed report from the buyer, the seller may, at his discretion:
a) supply the products ex-factory to the buyer - same type and quantity of the defective ones - only after receiving and checking the defective ones. Any replacement carried out promptly by the seller, cannot be considered as implicit recognition of the claimed defects.
After inspection, if the goods result not defective, the seller will invoice the ones sent in replacement;
b) issue a credit-note to the buyer of the same value of the defective products.
In both cases the buyer will return the faulty products to the seller.

8. Returned goods

The buyer should receive a written authorization of the seller before sending back the goods. The authorized goods will be delivered free our warehouse in San Maurizio d'Oglio. The credit note for the returned goods will be settled only after reception and inspection of the goods, done by our quality control department. Damages caused to the products or bad and/or not original packaging will be deducted from the credit note.

9. Payments

The payments and every other sum due to the seller, are understood as net at the registered office of the seller. Payments must be settled within the established date, also in case of late delivery or loss of total / partial merchandise is not attributable to the seller. Any delay or irregularity in the payment gives the seller the right to suspend the supply or to cancel the existing contract, even if they are not relevant to the payments in question, as well as the right to balance of eventual damages. The seller has also the right - starting from the payment deadline - to debit the interests for delay as per art. 5 of Italian Legislative Decree no. 231 of 09/10/2002. The delays of payments, likewise, give the seller the right to exclude the guarantee. The customer has no right to balance and/or to deduct any payments, even when they are in dispute.

10. Retention of Title

The delivered products remain seller's property until the moment of the complete payment of the price.

11. Applicable Law and Competent Law-Court

All Contracts ruled by these general conditions are submitted to Italian Law. For any controversy relative to, or connected to the contractual products to which these general conditions apply, Novara court has exclusive competence.

12. Minimum order value

NATIONAL MARKET ITALY
For order value lower than € 250,00, Mario Bongio S.r.l. will debit an extra cost of € 20,00 for administrative expenses
The minimum order value required for free destination delivery is € 600,00.

EU MARKET

For order value lower than € 250,00, Mario Bongio S.r.l. will debit an extra cost of € 20,00 for administrative expenses. The minimum order value required for free destination delivery is € 800,00.

EXTRA-EU MARKET

For order value lower than € 250,00 Mario Bongio S.r.l. will debit an extra cost of € 40,00 for administrative expenses.
Certificates of Origin or other extra documents will be debited separately and based on each single request of the buyer. The minimum order value required for free destination delivery is € 1500,00.

13. Paper or electronic catalogues

The images of the products, they represent each article but must not be considered as perfect reproductions of the real piece. Especially for as concerns the colours and/or the finishes represented in the catalogues, price lists, pictures, web site, social media, samples or any other marketing object, they should be considered purely indicative and they cannot be denounced as a flaw, as they do not modify the essential qualities of the product itself. Mario Bongio S.r.l. reserve the right to make changes, either aesthetic or techniques, without warning anyone, as well as proceeding with elimination of individual articles or complete series from the production.

14. Acceptance of conditions

The execution of the contract with the acceptance of the goods by the buyer, it will be considered as implicit acceptance of these conditions.

This catalogue deletes and replaces the previous editions.

The details therein contained may change without any prior notice.



Mario Bongio S.r.l.
via Aldo Moro, 2 - C.P. 108
28017 - San Maurizio d'Opaglio
Novara - Italia
T: +39 0322 96 72 48
F: +39 0322 95 00 12

www.bongio.it - info@bongio.it
www.bongio.com - www.bongiocasa.it

Follow us:

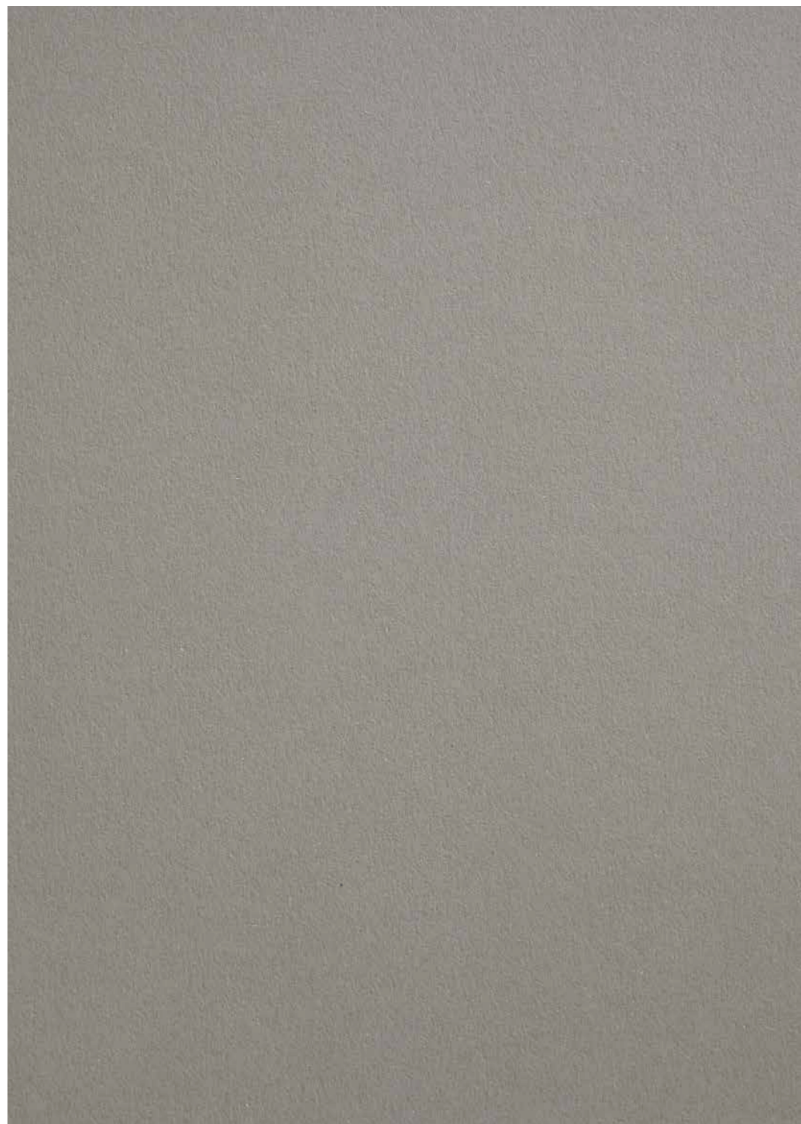

bongio®

MADE IN ITALY SINCE 1936

Mario Bongio S.r.l.

via Aldo Moro, 2 - C.P. 108
28017 - San Maurizio d'Opaglio
Novara - Italia
T: +39 0322 96 72 48
F: +39 0322 95 00 12

www.bongio.it - info@bongio.it
www.bongio.com - www.bongiocasa.it

Follow us:

