



ARCHI

M O D E L S

2021

MICROFONO

DESIGN ARCH. SEGRE + ROSA



rubinetti d'autore made in Italy



# index

progetto su misura	2
finiture d'autore	3
fotografico	4
listino prezzi	13

COLLEZIONI D'AUTORE



manifattura completamente italiana

# progetto su misura - customizing project

## prodotto

Ad architetti e progettisti si vuole offrire l'opportunità di un servizio esclusivo, PROGETTO SU MISURA, personalizzando gli elementi in funzione di specifiche richieste estetiche o problematiche legate a vincoli progettuali. Oltre trenta linee, sviluppate su scala industriale si prestano ad essere modificate nelle dimensioni, nei componenti e nelle finiture per diventare la soluzione ideale in tutte le situazioni in cui è necessario uscire dagli standard.

Per informazioni e richieste PROGETTI SU MISURA: [ufficiotecnico3@bellostarubinetterie.com](mailto:ufficiotecnico3@bellostarubinetterie.com)

## product

To any architects or designers we would offer an exclusive service, the PROGETTO SU MISURA, by customizing the elements in relationship at specific aesthetic request or about projection duty. The size, components and finishings of over thirty industrial scale lines can be modified to perfectly fit all those situations that demand non-standard solutions.

For informations and PROJECTS "SU MISURA" requests: [ufficiotecnico3@bellostarubinetterie.com](mailto:ufficiotecnico3@bellostarubinetterie.com)

## colore

Il servizio PROGETTO SU MISURA non si limita alla personalizzazione a 360° delle componenti dimensionali del prodotto. La scelta della finitura a volte ricade sul cromato perchè è difficile trovare nei complementi di arredo la stessa tonalità. Grazie a SU MISURA COLORS è possibile ottenere lo stesso colore sia sugli articoli presenti a listino sia sui componenti non prodotti da Bellosta Rubinetterie: maniglie, cerniere wc, piedini vasca, applique, profili doccia sono solo alcuni degli elementi realizzabili nella finitura scelta.

E' possibile inviare all'ufficio tecnico i complementi che si desidera ritrattare, per poterne valutare la fattibilità.





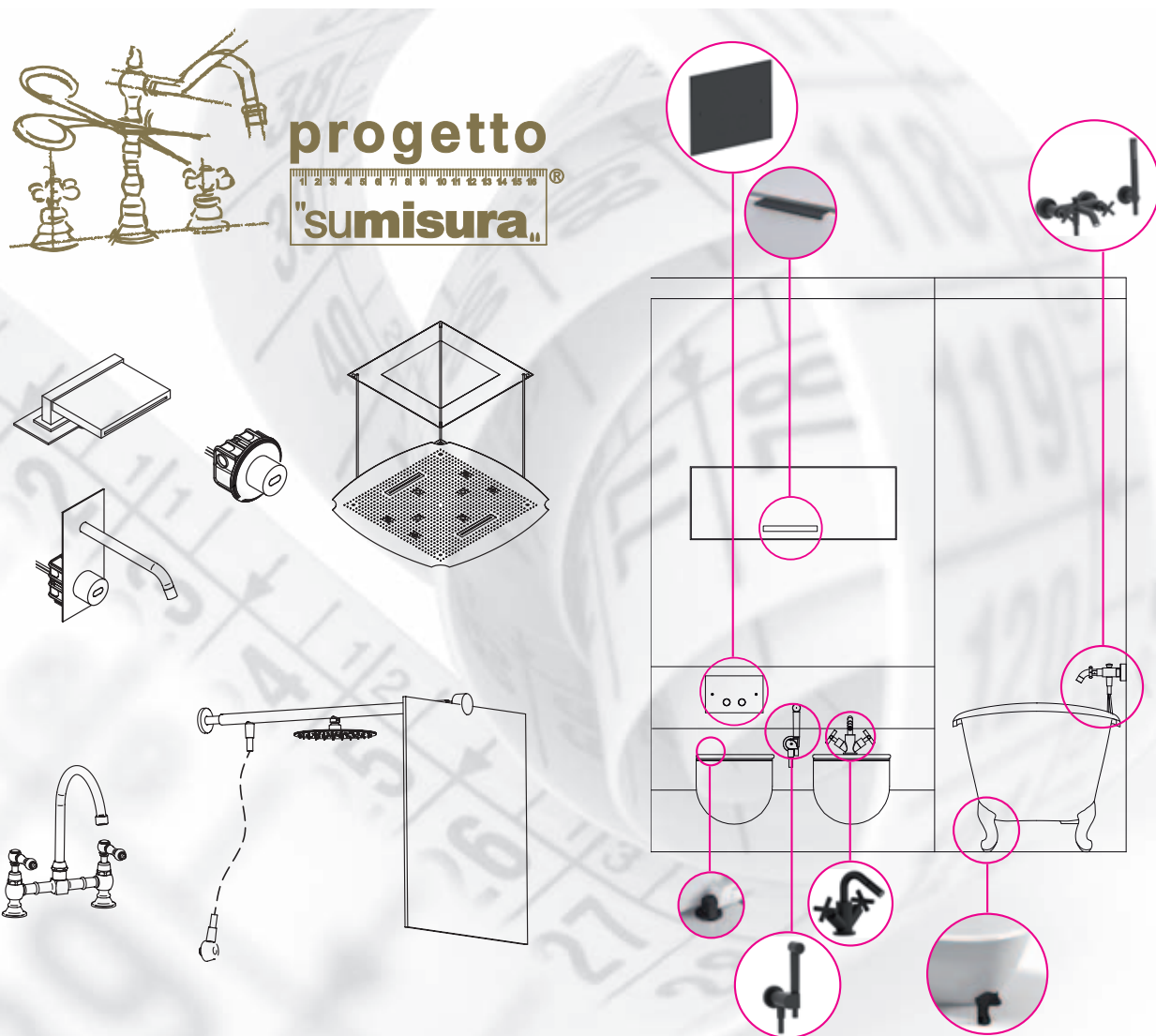





































## color

The PROGETTO SU MISURA service is not limited to the 360° customization of the dimensional components of the product. The choice of finish sometimes point on the chrome because it is difficult to find the same tonality in the furnishing complements. Thanks to SU MISURA COLORS, it is possible to obtain the same color on both the faucet collection and the components not produced by Bellosta Rubinetterie: handles, hinges, bathtub legs, applique, shower profiles are just some of the elements that the company can turn into the finishing choice. It is possible to send to the technical office the complements that you would like to retract, in order to evaluate the feasibility.



# finiture d'autore - artist finishing

Anteporre il codice finitura al codice articolo. Es: **01-codice articolo** per finitura cromato.  
Before the code article insert the reference finish. Ex: **01-code** for the chrome color.

 <b>01</b> cromato chrome	 <b>13</b> ottone naturale natural brass	 <b>59</b> marrone brown	 <b>88</b> ottone sisal sisal brass
 <b>02</b> cromo/oro chrome/gold	 <b>14</b> bianco white	 <b>60</b> arancio orange	 <b>89</b> industrial industrial
 <b>03</b> oro/argento gold/silver	 <b>19</b> nero black	 <b>61</b> rosso red	 <b>92</b> pomice opaco matt pumice
 <b>04</b> dorato gold	 <b>28</b> nickel satinato satin nickel	 <b>66</b> bianco opaco matt white	 <b>93</b> arenaria opaco matt sandstone
 <b>05</b> bronzo satinato satin bronze	 <b>30</b> nickel lucido polished nickel	 <b>67</b> nero opaco matt black	 <b>94</b> tuscany spazzolato brushing tuscany
 <b>06</b> rame vecchio old copper	 <b>33</b> cromo satinato satin chrome	 <b>68</b> rame opaco matt copper	 <b>95</b> rame acidato etched copper
 <b>07</b> vecchio argento old silver	 <b>34</b> cromo spazzolato brushing chrome	 <b>69</b> argento opaco matt silver	 <b>96</b> cemento opaco matt cement
 <b>08</b> canna di fucile gun barrel	 <b>35</b> nickel spazzolato brushing nickel	 <b>71</b> oro opaco matt gold	 <b>A1</b> brina opaco matt frost
 <b>10</b> verderame verdigris	 <b>56</b> avorio ivory	 <b>72</b> bronzo opaco matt bronze	 <b>A2</b> tuscany cerato oilskin tuscany
 <b>11</b> nero antracite anthracite black	 <b>57</b> azzurro light blue	 <b>75</b> dorato spazzolato brushing gold	 <b>A3</b> ottone acidato etched brass
 <b>12</b> ottone lucido polished brass	 <b>58</b> verdino light green	 <b>87</b> oro rosa pink gold	 <b>A4</b> basalto opaco matt basalt

## garanzia

Si ricorda che la Garanzia sulle finiture DECADE nel momento in cui manutenzione e pulizia NON vengano effettuate in modo adeguato e continuativo.

## warranty

Please note that the Warranty on finishes DECADE when maintenance and cleaning NOT be made adequately and continuously.

Le finiture d'autore Bellostà sono il risultato dell'artigianalità della produzione italiana della nostra azienda: eventuali differenze di tonalità non sono da considerarsi difetto, ma caratteristica di unicità del prodotto.

Bellostà color finishes are the result of a handcrafted Italian production of our firm: any eventual difference of shade, are not to consider like a defect, but like a unique featuring of the product.

## manutenzione e pulizia

Asciugare sempre con un panno morbido immediatamente dopo l'uso. Non utilizzare mai detersivi, agenti chimici, spugne abrasive, pagliette metalliche, alcool, che danneggerebbero irrimediabilmente le superfici del prodotto. Pulire esclusivamente con sapone neutro, abbondante acqua asciugare con panno morbido.

## maintenance and cleaning

Always dry with a soft cloth immediately after use. Never use detergents, chemicals, abrasive sponges, scouring pads, alcohol, which could cause irreparable damage to the product surfaces. Clean only with natural/fresh soap, plenty of water and dry with a soft cloth.

# MICROFONO

DESIGN ARCH. FRANCO SEGRE + MICHELE ROSA



66-6913/5/1 bianco opaco  
matt white





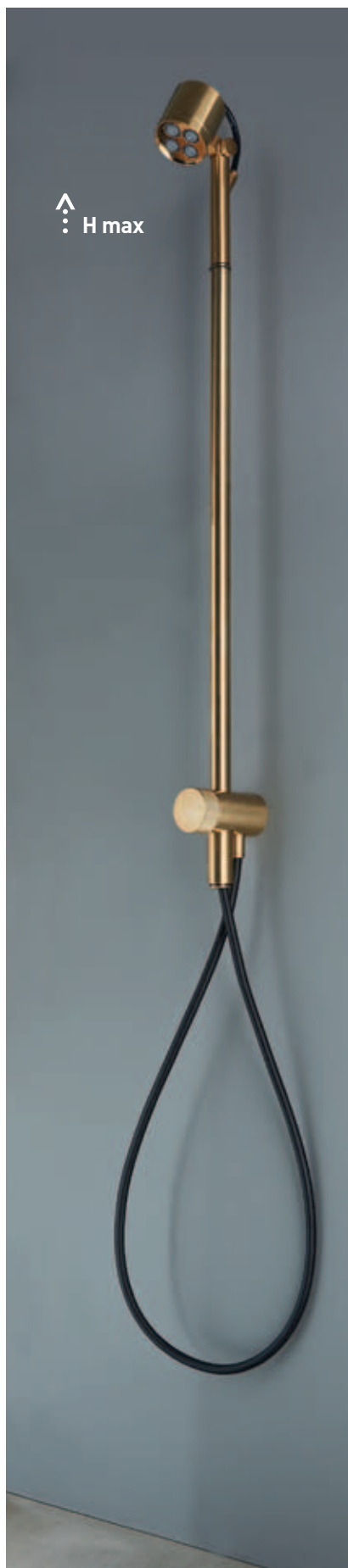

MODALITÀ SOFFIONE  
CEILING MODE



MODALITÀ SALISCENDI  
WALL PIPE MODE



MODALITÀ DOCCETTA DI SERVIZIO  
HAND SHOWER MODE



72-6931/D/SP

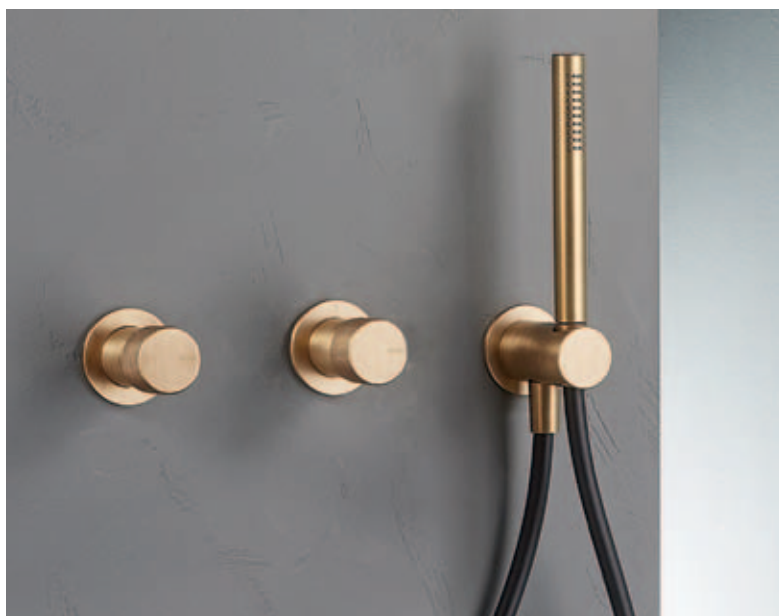

72-6905/R/B/E + 01-104033, 72-6903/2/1/E + 914016, 72-6903/1/A



SOFFIONE ORIENTABILE  
ADJUSTABLE CEILING



DOCCETTA ESTRAIBILE  
PULL OUT SPRAY



89-6913/5/1



78-6931/D/SP  
01-6912/3/P/E + 694012  
01-6913/5/1



67-6931/D/SP

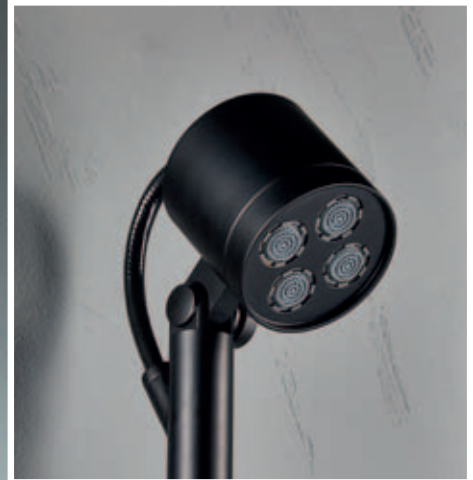

67-6912/3/P/E + 694012

67-6931/D/SP  
67-6905/R/B/E + 01-104033  
67-6903/3/1/E + 034127  
67-6913/5/1  
67-6903/1/A



35-6913/5/1



A1-6913/5/1



# listino prezzi microfono



tabella prezzi finiture	pag. 14
info tecniche	pag. 15
esempi composizioni doccia	pag. 17
indice / index	pag. 18
listino prezzi	pag. 19

**PREZZO FINITURE**

Calcola il prezzo di listino (IVA esclusa) delle finiture diverse dal cromato, consultando la seguente tabella.

Moltiplicare il **PREZZO LISTINO** per il **COEFFICIENTE MOLTIPLICATORE** della finitura scelta, arrotondando per difetto il prezzo ottenuto (eliminare i centesimi).  
**ESEMPIO** per ordinare art. 6913/5/1 in finitura dorato: codice **04-6913/5/1**

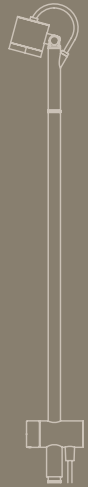
**COMPOSIZIONE CODICE PER ORDINARE ARTICOLO IN FINITURA**



**CODICE FINITURA** / **FINISH CODE**      **CODICE ARTICOLO** / **ITEM NUMBER**

**PRICE FINISHES**

Include the list price (excluding VAT) of different finishes from chrome, consulting the following table. **Multiply the PRICE LIST MULTIPLIER COEFFICIENT** of the chosen finish, reducing the price obtained by deleting the centesim.

**EXAMPLE** to order art. 6913/5/1 gold finish: code **04-6913/5/1**

**FINITURE DI SERIE / STANDARD FINISHES**

COD. CODE	DESCRIZIONE FINITURA FINISH DESCRIPTION	MOLTIPLICATORE MULTIPLIER
01-	cromato / chrome	PREZZO LISTINO°
78-	inox 304 lucido/cromo	PREZZO LISTINO°

**FINITURE A RICHIESTA / ON REQUEST FINISHES**

COD. CODE	DESCRIZIONE FINITURA FINISH DESCRIPTION	1° GRUPPO	2° GRUPPO
57-	azzurro / light blue		
58-	verdino / light green		
59-	marrone / brown		
60-	arancio / orange		
61-	rosso / red		
66-	bianco opaco / matt white		
67-	nero opaco / matt black		
68-	rame opaco / matt copper		
69-	argento opaco / matt silver		
71-	oro opaco / matt gold		
72-	bronzo opaco / matt bronze		
75-	dorato spazzolato / brushing gold		
87-	oro rosa / pink gold		
88-	ottone sisal / sisal brass		
89-	industrial		
92-	pomice opaco / matt pumice		
93-	arenaria opaco / matt sandstone		
94-	tuscany spazzolato / brushing tuscany		
95-	rame acidato / etched copper		
96-	cemento opaco / matt cement		
A1-	brina opaco / matt frost		
A2-	tuscany cerato / oilskin tuscany		
A3-	ottone acidato / etched brass		
A4-	basalto opaco / matt basalt		

**FINITURE A RICHIESTA / ON REQUEST FINISHES**

COD. CODE	DESCRIZIONE FINITURA FINISH DESCRIPTION	1° GRUPPO	2° GRUPPO
02-	cromo/oro / chrome/gold		
03-	oro/argento / gold/silver		
04-	dorato / gold		
05-	bronzo satinato / satin bronze		
06-	rame vecchio / old copper		
07-	vecchio argento / old silver		
08-	canna di fucile / gun barrel		
10-	verderame / verdigris		
11-	nero antracite / anthracite black		
12-	ottone lucido / polished brass		
13-	ottone naturale / natural brass		
14-	bianco / white		
19-	nero / black		
28-	nickel satinato / satin nickel		
30-	nickel lucido / polished nickel		
33-	cromo satinato / satin chrome		
34-	cromo spazzolato / brushing chrome		
35-	nickel spazzolato / brushing nickel		
56-	avorio / ivory		

°PREZZO DI LISTINO / PRICE LIST

N.R. = NON REALIZZABILE / NOT MADE

**ATTENZIONE! 13-OTTONE NATURALE e 88-OTTONE SISAL:** finiture non protette che antichizzano naturalmente ossidando a contatto con l'umidità atmosferica.  
**WARNING! 13-NATURAL BRASS and 88-SISAL BRASS:** unprotected finishes that naturally oxidise in contact with atmospheric humidity.

(!) PER LE FINITURE E I RELATIVI MOLTIPLICATORI DEI CODICI RICAMBI CONSULTARE IL LISTINO RICAMBI O CONTATTARE IL REFERENTE COMMERCIALE.  
 (!) FOR THE FINISHES AND RELATIVE MULTIPLIERS OF SPARE PARTS CODES, CONSULT THE SPARE PARTS PRICE LIST OR CONTACT THE SALE REFERENT.



ELENCO ARTICOLI SUDDIVISI PER CATEGORIA MOLTIPLICATORI FINITURE:

1° GRUPPO

- 6913/5/1
- 6905/R/B/E
- 6903/2/1/E
- 6903/3/1/E
- 6903/4/1/E
- 6912/P/E
- 6912/2/P/E
- 6912/3/P/E
- 6912/4/P/E
- 6903/1/A

2° GRUPPO

- 6931/D/SP

**SCHEMA FUNZIONAMENTO DEVIATORI INCASSO 2/3/4 USCITE**

Questi deviatori non hanno funzione di chiusura. Ruotando verso destra o sinistra si attivano le uscite. Tra 2 uscite adiacenti durante la rotazione diminuisce la portata dell'uscita iniziale ed incrementa quella della successiva. In posizione intermedia sono entrambe attive a pari portata.

**SCHEME OPERATION SWITCHES FLUSH OUTPUT 2/3/4**

These diverters have not closing function. By turning to the right or left activates the outputs. Between two adjacent outputs during the rotation decreases the initial output flow and increases that of the next. In position intermediate are both active at the same flow rate.

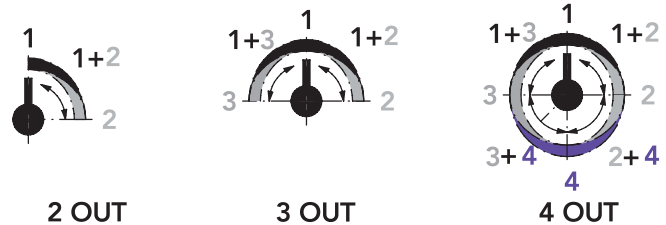

**SCHEMA FUNZIONAMENTO MISCELATORI TERMOSTATICI 2/3/4 USCITE**

Leva in posizione ore 12 = deviatore chiuso. Ruotando verso destra o sinistra si attivano le diverse uscite. Partendo dalla posizione di STOP, durante la rotazione la portata dell'acqua si incrementa verso la posizione successiva. Tra 2 uscite adiacenti durante la rotazione diminuisce la portata dell'uscita iniziale ed incrementa quella della successiva. In posizione intermedia sono entrambe attive a pari portata.

**SCHEME OPERATING THERMOSTATIC MIXER 2/3/4 OUT**

Lever to the 12 o'clock position = switch closed. Turning left or right. They activate different outputs. Starting from the STOP position, while rotation of the water flow rate between two adjacent outputs is increased towards the next position. Between two adjacent outputs during the rotation decreases the initial output flow and increases that of the next. In position intermediate are both active at the same flow rate.

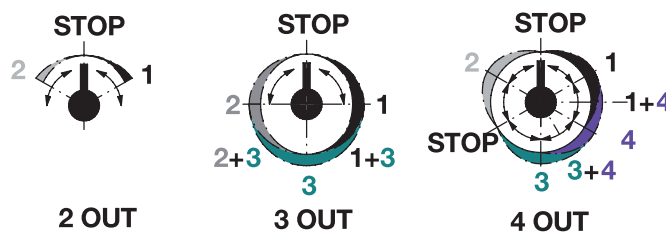

**DATI TECNICI PER IMPIANTO IDRAULICO COLLEZIONE "MICROFONO"**

Pressione minima di esercizio: 2 bar  
 Pressione di esercizio - campo di impiego ottimale consigliato: 3÷4 bar  
 Pressione massima di esercizio: 5 bar (Per pressioni idrauliche superiori si raccomanda l'installazione di un riduttore di pressione)  
 Temperatura massima d'esercizio: 65°C  
 Richiesto scarico a pavimento DN40 secondo la normativa europea EN274 (31 l/min con piatto doccia senza battente idraulico)

**THECNICAL DATES FOR HYDRAULIC PLANT "MICROFONO" COLLECTION**

Minimum pressure: 2 bar  
 Pressure - optimal recommended use: 3÷4 bar  
 Maximum pressure: 5 bar (for higher hydraulic pressure it is recommended a pressure reducer)  
 Maximum temperature: 65°C  
 Requested floor waste DN40 on the european law EN274 (31 l/min with flat shower without hydraulic batten)

Le finiture d'autore Bellostà sono il risultato dell'artigianalità della produzione italiana della nostra azienda: eventuali differenze di tonalità non sono da considerarsi difetto, ma caratteristica di unicità del prodotto.

Bellosta color finishes are the resulted of an handcrafted italian production of our firm: any eventual difference of shade, are not to consider like a defect, but like a unique featuring of the product.

**GARANZIA FINITURE**

Si ricorda che la Garanzia sulle finiture DECADE nel momento in cui manutenzione e pulizia NON vengano effettuate in modo adeguato e continuativo.

**FINISHINGS WARRANTY**

Please note that the Warranty on finishes DECAY when maintenance and cleaning NOT be made adequately and continuously.

**MANUTENZIONE E PULIZIA**

Asciugare sempre con un panno morbido immediatamente dopo l'uso. Non utilizzare mai detersivi, agenti chimici, spugne abrasive, pagliette metalliche, alcool, che danneggerebbero irrimediabilmente le superfici del prodotto. Pulire esclusivamente con sapone neutro, abbondante acqua asciugare con panno morbido.

**MANTENAINCE AND CLEANING**

Always dry with a soft cloth immediately after use. Never use detergents, chemicals, abrasive sponges, scouring pads, alcohol, which could cause irreparable damage to the product surfaces. Clean only with natural/fresh soap, plenty of water and dry with a soft cloth.

**SCHEMA FUNZIONAMENTO STELO REGOLABILE**

Lo stelo della serie MICROFONO è regolabile in altezza e inclinazione.  
 Per modificare altezza ruotare in senso antiorario la maniglia centrale, posizionare colonna ad altezza desiderata e bloccare nuovamente la maniglia ruotandola in senso orario.  
 Per modificare inclinazione del soffione ruotare in senso antiorario la maniglietta laterale, posizionare soffione con inclinazione desiderata e bloccare nuovamente la maniglietta ruotandola in senso orario.

**FUNCTION SCHEME FOR REGULABLE STEM**

The stem of the MICROFONO series could be regulated in height and inclination.  
 To modify the height, turn the central handle counter-clockwise, position the column at the desired height and lock the handle again turning it clock-wise.  
 To change the angle of ceiling, turn the counter-clockwise side handle, position the ceiling with the desired angle and lock the handle again by turning it clock-wise.

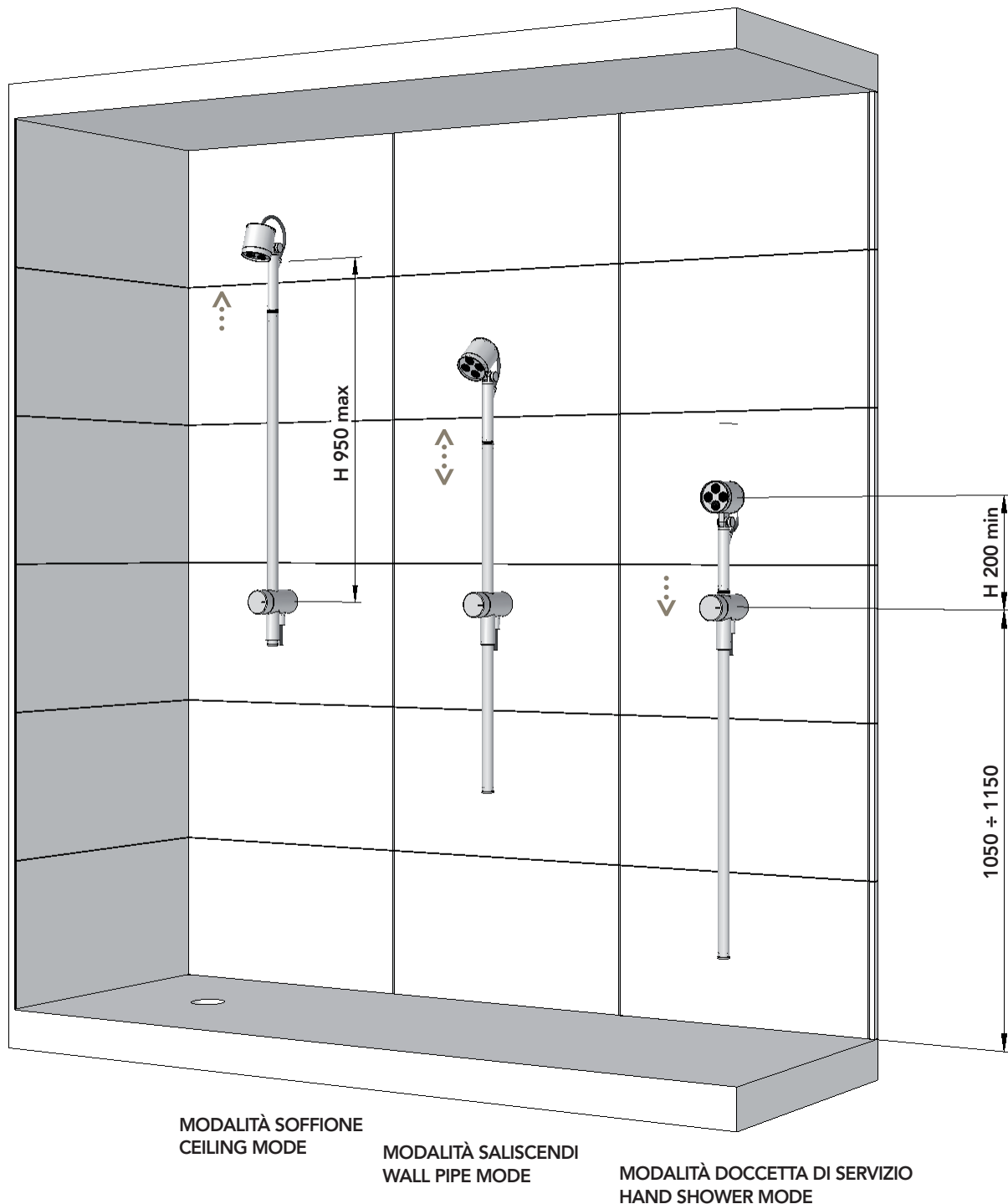

Per il corretto funzionamento è consigliabile una pressione dinamica di almeno 2 bar ed una portata d'acqua di 18 lt/min. Scarico consigliato foro Ø90.  
 ATTENZIONE: per questa combinazione è necessario uno spessore minimo della parete di almeno mm 80.

For the correct function it's suggest to have a dynamic pressure not less than 2 bar and a water flow about 18 lt/min. Suggest waste hole Ø90  
 PAY ATTENTION: For this featuring is necessary a minimum wall depth not less than mm 80.

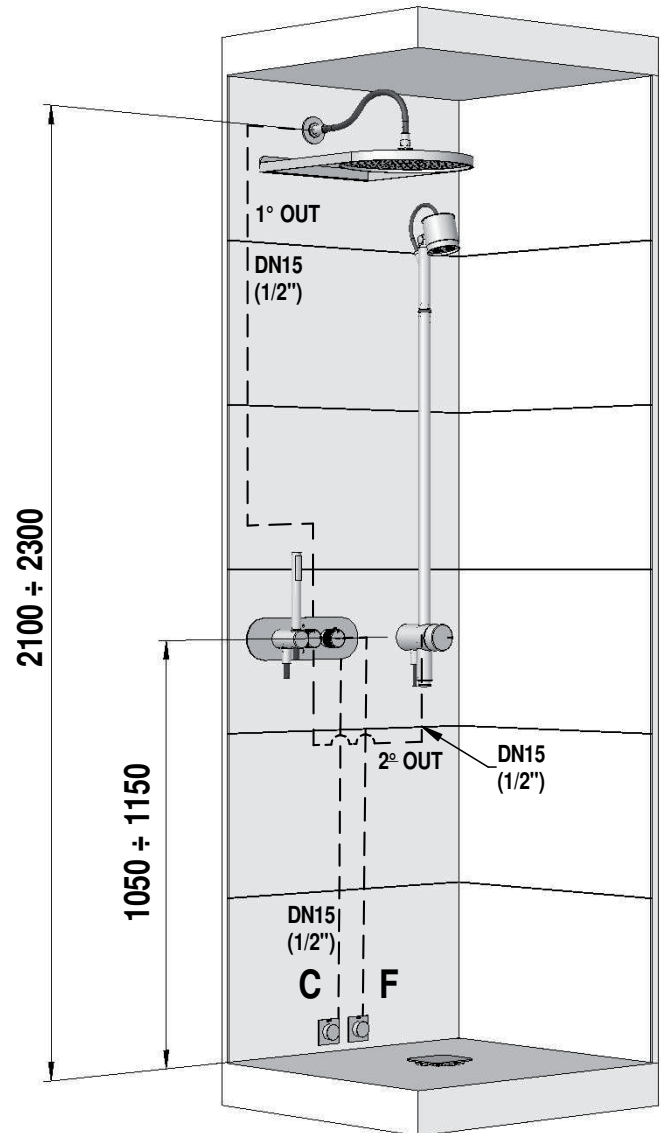
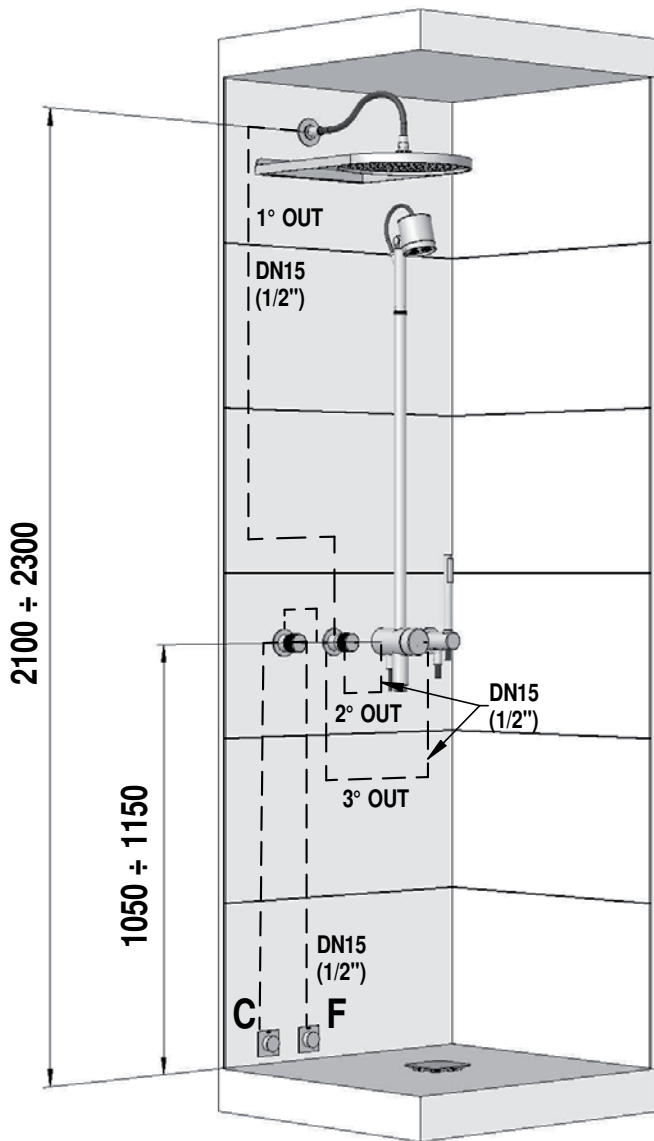

ARTICOLO	QUANTITA'
01-6905/R/B/E + 01-104033	1
01-6903/3/1/E + 034127	1
01-6913/5/1	1
01-6903/1/A	1
78-6931/D/SP	1
01-8816/E + 775025	1
TOTALE	

ARTICOLO	QUANTITA'
01-6912/3/P/E + 694012	1
01-6913/5/1	1
78-6931/D/SP	1
01-8816/E + 775025	1
TOTALE	



**6913/5/1** pag. 19

STELO DOCCIA REGOLABILE  
REGULABLE ROD SHOWER



**6905/R/B/E + 104033** pag. 19

MISCELATORE INCASSO REMOTO  
BUILT-IN REMOTE MIXER

parti esterne / external parts: 6905/R/B/E  
parte incasso / built-in part: 104033



**6903/2/1/E + 914016** pag. 19

DEVIATORE INCASSO 2 USCITE  
BUILT-IN DIVERTER 2 OUT



parti esterne / external parts: 6903/2/1/E  
parte incasso / built-in part: 914016



**6903/3/1/E + 034127** pag. 19

DEVIATORE INCASSO 3 USCITE  
BUILT-IN DIVERTER 3 OUT



parti esterne / external parts: 6903/3/1/E  
parte incasso / built-in part: 034127



**6903/4/1/E + 034128** pag. 20

DEVIATORE INCASSO 4 USCITE  
BUILT-IN DIVERTER 4 OUT



parti esterne / external parts: 6903/4/1/E  
parte incasso / built-in part: 034128



**6912/P/E + 484020** pag. 20

MISCELATORE TERMOSTATICO INCASSO 1 USCITA  
BUILT-IN THERMOSTATIC MIXER 1 OUT



parti esterne / external parts: 6912/P/E  
parte incasso / built-in part: 484020



**6912/2/P/E + 694011** pag. 20

MISCELATORE TERMOSTATICO INCASSO  
C/DEVIATORE 1+1 USCITE  
BUILT-IN THERMOSTATIC MIXER WITH DIVERTER 1+1  
OUT



parti esterne / external parts: 6912/2/P/E  
parte incasso / built-in part: 694011



**6912/3/P/E + 694012** pag. 20

MISCELATORE TERMOSTATICO INCASSO  
C/DEVIATORE 1+2 USCITE  
BUILT-IN THERMOSTATIC MIXER WITH DIVERTER  
1+2 OUT



parti esterne / external parts: 6912/3/P/E  
parte incasso / built-in part: 694012



**6912/4/P/E + 694013** pag. 21

MISCELATORE TERMOSTATICO INCASSO  
C/DEVIATORE 1+3 USCITE  
BUILT-IN THERMOSTATIC MIXER WITH DIVERTER  
1+3 OUT



parti esterne / external parts: 6912/4/P/E  
parte incasso / built-in part: 694013



**6903/1/A** pag. 21

SUPPORTO DOCCIA COMPLETO  
FULL SHOWER SUPPORT



**6931/D/SP** pag. 21

SISTEMA DOCCIA DA PARETE  
WALL SHOWER SYSTEM

6913/5/1

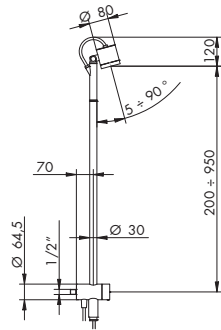

STELO DOCCIA REGOLABILE

- > stelo regolabile in altezza
- > doccetta estraibile snodata Ø80 in ottone
- > con 4 diffusori anticalcare orientabili
- > flessibile PVC 260 cm
- > ingresso da 1/2"

CROMATO	
01-6913/5/1	€

ALTRE FINITURE	
XX-6913/5/1	€ x M*

>> LISTINO PREZZI PRESSO RIVENDITORI AUTORIZZATI

6905/R/B/E + 104033

[parte esterna] [parte incasso]

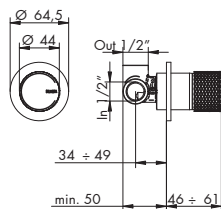

MISCELATORE INCASSO REMOTO

- > cartuccia tradizionale
- > ingressi da 1/2"
- > uscita superiore
- > senza scarico

 025002  
€  
p. 149 - list. ricambi

PARTI ESTERNE - CROMATO	
01-6905/R/B/E	€

PARTI ESTERNE - ALTRE FINITURE	
XX-6905/R/B/E	€ x M*

PARTE INCASSO	
01-104033	€

PREZZO TOTALE	
	€

>> LISTINO PREZZI PRESSO RIVENDITORI AUTORIZZATI

6903/2/1/E + 914016

[parte esterna] [parte incasso]

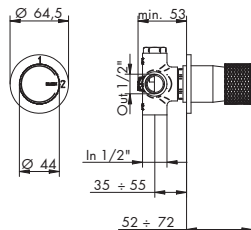

DEVIATORE INCASSO 2 USCITE

- > deviatore a dischi ceramici 2 uscite senza chiusura
- > attacchi da 1/2"

 635010  
€  
p. 131 - list. ricambi

PARTI ESTERNE - CROMATO	
01-6903/2/1/E	€

PARTI ESTERNE - ALTRE FINITURE	
XX-6903/2/1/E	€ x M*

PARTE INCASSO	
914016	€

PREZZO TOTALE	
	€

>> LISTINO PREZZI PRESSO RIVENDITORI AUTORIZZATI

6903/3/1/E + 034127

[parte esterna] [parte incasso]

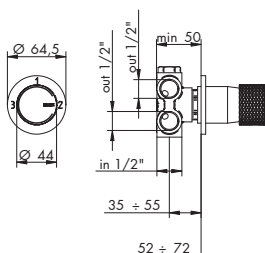

DEVIATORE INCASSO 3 USCITE

- > deviatore a dischi ceramici 3 uscite senza chiusura
- > attacchi da 1/2"

 635011  
€  
p. 131 - list. ricambi

PARTI ESTERNE - CROMATO	
01-6903/3/1/E	€

PARTI ESTERNE - ALTRE FINITURE	
XX-6903/3/1/E	€ x M*

PARTE INCASSO	
034127	€

PREZZO TOTALE	
	€

>> LISTINO PREZZI PRESSO RIVENDITORI AUTORIZZATI

RICAMBI IMMEDIATI



XX = CODICE FINITURA RICHIESTA: per identificare codice corretto vedi pag. 14  
M\* = MOLTIPLICATORE: per calcolare il prezzo delle altre finiture vedi tabella pag. 14

**6903/4/1/E + 034128**

[parte esterna] [parte incasso]

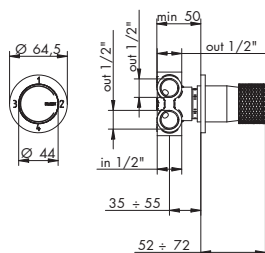

**DEVIATORE INCASSO 4 USCITE**

> deviatore a dischi ceramici 4 uscite senza chiusura  
> attacchi da 1/2"

 **635012**  
€  
p. 131 - list. ricambi

**PARTI ESTERNE - CROMATO**

01-6903/4/1/E €

**PARTI ESTERNE - ALTRE FINITURE**

XX- 6903/4/1/E € x M\*

**PARTE INCASSO**

034128 €

**PREZZO TOTALE** €

>> LISTINO PREZZI PRESSO RIVENDITORI AUTORIZZATI

**6912/P/E + 484020**

[parte esterna] [parte incasso]

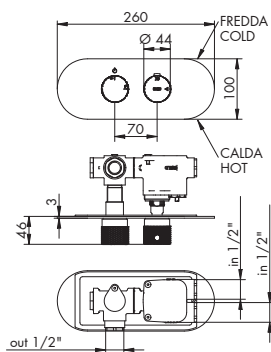
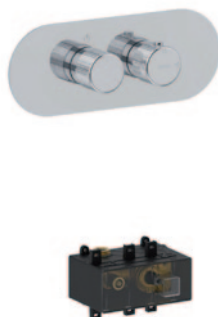

**MISCELATORE TERMOSTATICO INCASSO 1 USCITA**

> cartuccia termostatica  
> vitone ceramico 90°  
> apertura con rotazione antioraria  
> interasse 70 mm  
> ingressi lato destro da 1/2"  
> uscita superiore da 1/2"  
> incasso con B-Box  
> piastra unica

> incasso regolabile min 76  
> 2 maniglie

 **775007**  
€  
p. 220 - list. ricambi

 **055134**  
€  
p. 220 - list. ricambi

**PARTI ESTERNE - CROMATO**

01-6912/P/E €

**PARTI ESTERNE - ALTRE FINITURE**

XX- 6912/P/E € x M\*

**PARTE INCASSO**

484020 €

**PREZZO TOTALE** €

>> LISTINO PREZZI PRESSO RIVENDITORI AUTORIZZATI

**6912/2/P/E + 694011**

[parte esterna] [parte incasso]

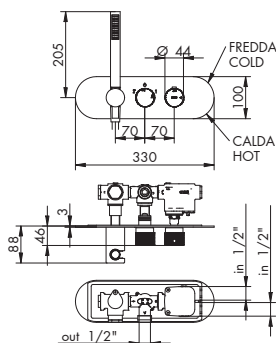

**MISCELATORE TERMOSTATICO INCASSO C/DEVIATORE 1+1 USCITE**

> cartuccia termostatica  
> deviatore a dischi ceramici 2 uscite c/chiusura  
> interasse 70 mm  
> ingressi lato destro da 1/2"  
> incasso con B-Box  
> piastra unica  
> gancio doccia integrato

> uscita superiore da 1/2"  
> incasso regolabile min 76  
> 2 maniglie

 **775007**  
€  
p. 220 - list. ricambi

**PARTI ESTERNE - CROMATO**

01-6912/2/P/E €

**PARTI ESTERNE - ALTRE FINITURE**

XX- 6912/2/P/E € x M\*

**PARTE INCASSO**

694011 €

**PREZZO TOTALE** €

>> LISTINO PREZZI PRESSO RIVENDITORI AUTORIZZATI

**6912/3/P/E + 694012**

[parte esterna] [parte incasso]

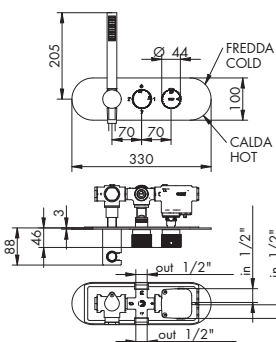

**MISCELATORE TERMOSTATICO INCASSO C/DEVIATORE 1+2 USCITE**

> cartuccia termostatica  
> deviatore a dischi ceramici 3 uscite c/chiusura  
> interasse 70 mm  
> ingressi lato destro da 1/2"  
> uscite inferiore + superiore da 1/2"  
> incasso con B-Box  
> piastra unica  
> gancio doccia integrato

> incasso regolabile min 76  
> 2 maniglie

 **775007**  
€  
p. 220 - list. ricambi

 **035345**  
€ 49,00  
p. 212 - list. ricambi

**PARTI ESTERNE - CROMATO**

01-6912/3/P/E €

**PARTI ESTERNE - ALTRE FINITURE**

XX- 6912/3/P/E € x M\*

**PARTE INCASSO**

694012 €

**PREZZO TOTALE** €

>> LISTINO PREZZI PRESSO RIVENDITORI AUTORIZZATI



CARTUCCIA DEVIATRICE



CARTUCCIA TERMOSTATICA



VITONE CERAMICO

**6912/4/P/E + 694013**

[parte esterna] [parte incasso]

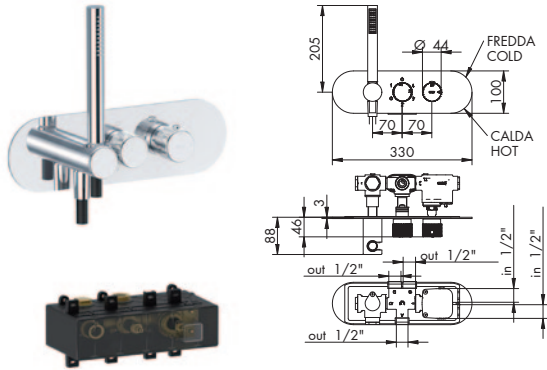

**MISCELATORE TERMOSTATICO INCASSO C/DEVIATORE 1+3 USCITE**

- > cartuccia termostatica
- > deviatore a dischi ceramici 4 uscite c/chiusura
- > interasse 70 mm
- > ingressi lato destro da 1/2"
- > 2 uscite inferiori+ uscita superiore da 1/2"
- > incasso con B-Box
- > piastra unica
- > gancio doccia integrato
- > incasso regolabile min 76
- > 2 maniglie

	<b>775007</b>	€	p. 220 - list. ricambi
	<b>035344</b>	€	p. 212 - list. ricambi

<b>PARTI ESTERNE - CROMATO</b>	<b>PARTI ESTERNE - ALTRE FINITURE</b>
01-6912/4/P/E €	XX- 6912/4/P/E € x M*
<b>PARTE INCASSO</b>	
694013 €	
<b>PREZZO TOTALE</b> €	

>> LISTINO PREZZI PRESSO RIVENDITORI AUTORIZZATI

**6903/1/A**

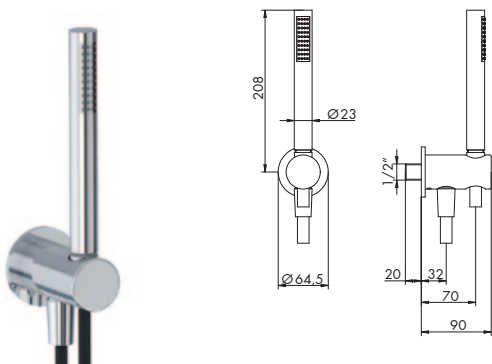

**SUPPORTO DOCCIA COMPLETO**

- > flessibile in PVC 150 cm
- > presa acqua con supporto fisso
- > attacchi da 1/2"
- > doccetta monogetto cilindrica in abs c/anticalcare
- > per finiture diverse da cromo doccetta in metallo

<b>CROMATO</b>	<b>ALTRE FINITURE</b>
01-6903/1/A €	XX-6903/1/A € x M*

>> LISTINO PREZZI PRESSO RIVENDITORI AUTORIZZATI

**6931/D/SP**

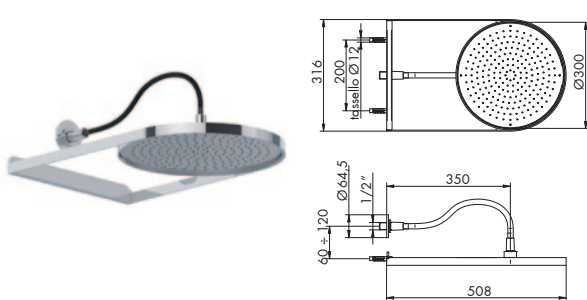

**SISTEMA DOCCIA DA PARETE**

- > erogazione solo pioggia
- > ugelli siliconici anticalcare
- > portata minima 12 lt/min 3 bar
- > singolo attacco a parete da 1/2"

<b>INOX 304 LUCIDO/CROMO</b>	<b>ALTRE FINITURE</b>
78-6931/D/SP €	XX-6931/D/SP € x M*

>> LISTINO PREZZI PRESSO RIVENDITORI AUTORIZZATI

**PROGETTO SU MISURA: RICHIESTE SPECIALI**

I tecnici di Bellosta Rubinetterie sono, inoltre, a disposizione di architetti e designers, per offrire un servizio esclusivo: personalizzazioni di elementi in funzione di specifiche richieste estetiche o problematiche legate a vincoli progettuali, verifica della fattibilità attraverso opportuni studi CAD e sviluppo del disegno tecnico del prodotto speciale richiesto. Per informazioni e richieste PROGETTI SU MISURA: ufficiotecnico@bellostarubinetterie.com

**PROGETTO SU MISURA: SPECIAL REQUESTS**

Engineers Bellosta Rubinetterie are also available to architects and designers, to offer an exclusive service: customizations of items according to specific aesthetic requirements or issues related to design constraints, verification of the feasibility studies and development through appropriate CAD technical design the required special product. For information and requests "SU MISURA" PROJECTS: ufficiotecnico@bellostarubinetterie.com

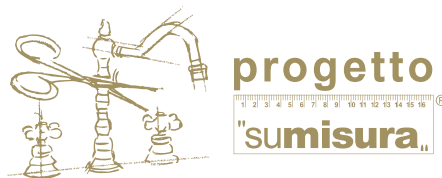









ASCOLTARE, PENSARE, FARE è la formula che abbiamo scelto per descrivere l'attenzione con cui interpretiamo i desideri del cliente, elaboriamo soluzioni ed esprimiamo proposte che ne soddisfino i gusti e le esigenze. Con lo stesso spirito, con lo stesso entusiasmo, oggi come sessant'anni fa.

LISTEN, THINK, ACT is the philosophy that we use to describe the attention by which we interpret the wishing of the client, we find solution and make proposal for meet the taste and exigent. With the same mind and passion, today like sixty years ago.

---

© 2021 Bellosta Rubinetterie. Tutti i diritti riservati.

GRAPHIC:  
Roberta Teruggi

CONCEPT:  
aCB

---

BELLOSTA CARLO & C. RUBINETTERIE Srl  
Via S. Botticelli, 12/14 | 28024 Briga Novarese (No) Italia  
Ingresso showroom: Largo Carlo Bellosta | Briga Novarese (No) Italia  
Atelier Milano: Via Montenapoleone, 22  
Atelier Roma: Piazza di Spagna, ingresso Via Gregoriana 23

T +39 0322 956 425 | 0322 912 330 | 0322 946 84  
F +39 0322 955 368 | [info@bellostarubinetterie.com](mailto:info@bellostarubinetterie.com)  
Export department: [estero@bellostarubinetterie.com](mailto:estero@bellostarubinetterie.com)

Follow us on facebook, youTube, linked in, twitter, pinterest, instagram, houzz

Visit our website on [bellostarubinetterie.com](http://bellostarubinetterie.com)

---

SPECIAL THANKS TO:  
Florim | [www.florim.com](http://www.florim.com)