

*Decor*  
**Stone**<sup>®</sup>

CATALOGO 2016

Decor Stone è un prodotto tecnologicamente perfetto, nato dalla sapiente esperienza della nostra azienda nel settore della lavorazione della polvere ricomposta. L'innovazione sostanziale e la visibile differenza rispetto ai prodotti attualmente in commercio consiste proprio nella materia prima utilizzata e cioè polvere di pietra naturale proveniente da cave selezionate miscelate con leganti resinosi di altissima qualità anziché polveri e coloranti cementizi ad alto assorbimento, come si riscontra comunemente. Decor Stone può essere utilizzata sia all'interno che all'esterno senza necessitare di alcun trattamento. Decor Stone dispone di una vasta gamma di serie che permettono di ricreare il gusto e i colori della tradizione.

*Decor Stone is a "State of the Art" product in the "engineered stone" field based upon the proven experience and excellent results achieved. Unrivalled innovation and extraordinary perception due to the raw material used, as compared to other engineered stone products marketed, are accomplished through the finest natural stone dusts carefully selected from premium grade quarries blended with quality resins instead of common cement based compounds and surface absorption oxidizing agents. Decor Stone is suitable both for interior and exterior applications requiring no sealing. Decor Stone consist of an extensive product range reproducing traditional taste and shades.*

## STONE COLLECTION

FARNESE .....	04
FARNESE LISTELLO .....	06
FARNESE XL .....	08
ROMANA .....	10
LOMBARDA .....	12
CHIGI .....	14
PEZZI SPECIALI per ARCHI.....	16
ORSINI .....	18

## MODERN COLLECTION

ARDESIA .....	22
ARDESIA XL .....	26
EXAGON .....	30
BOREAL .....	32
SHADES .....	33
ANTIQUE WOOD SERIES ....	34
RINEMI .....	35
SHADOW SERIES .....	36
SOLID MARBLE .....	37
LISTELLI. ....	38
ARREDO .....	39
Tecnologia /Test .....	40

stone collection  
 pietra  
**FARNESE**



MISCELE COLORI / SHADE BLENDS



M10



M30



H

SPECIFICHE / SPECIFICATIONS

Pietra Farnese è realizzata in spessori variabili da 0,8 cm a 2,8 cm.  
 Thickness may vary from  $3/8''$  to  $1 1/8''$ .

Pietra Farnese viene proposta nelle seguenti altezze approssimative: h 3 - h 7 - h 10.  
 Pietra Farnese is available in the following approximate heights: h  $1 1/5''$  - h  $2 3/4''$  - h  $4''$ .

Pietra Farnese deve essere posata rispettando scrupolosamente le ISTRUZIONI DI POSA riportate alla fine del presente catalogo.  
 The indicated SETTING INSTRUCTIONS must be carefully observed.

ATTENZIONE: Tutti i prodotti Decor stone devono essere utilizzati ESCLUSIVAMENTE PER RIVESTIMENTO, in nessun caso possono essere utilizzati per PAVIMENTAZIONI. Essendo i nostri prodotti composti con oltre il 90% di polvere di pietra naturale potrebbero riscontrarsi minime differenze nelle misure e nei toni.

NOTE: Decor stone products are intended to be used for covering applications only, any flooring setup is strictly prohibited.

Being essentially a natural stone product moderate shade and dimension variations could be observed.

PEZZI SPECIALI PER ANGOLI / CORNER PIECES

I pezzi speciali per angoli sono forniti a metro lineare e in tutte le varianti di colore / miscele disponibili per i fondi.

Corner pieces are supplied per linear metre and any indicated shade.

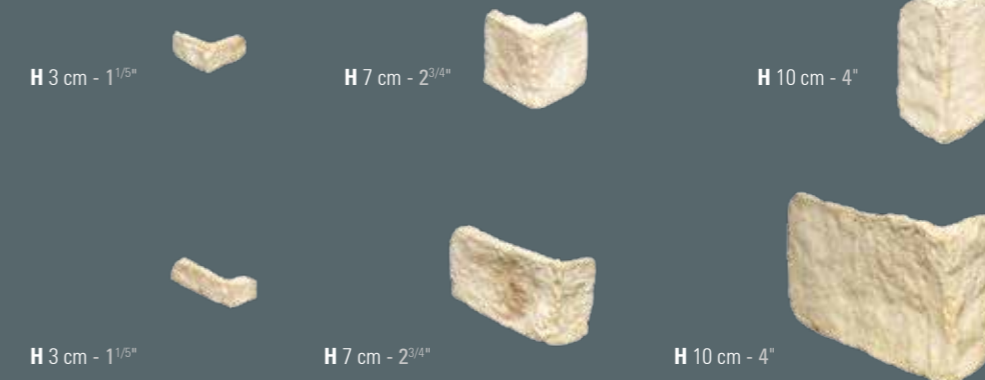



## MISCELE COLORI / SHADE BLENDS



M10

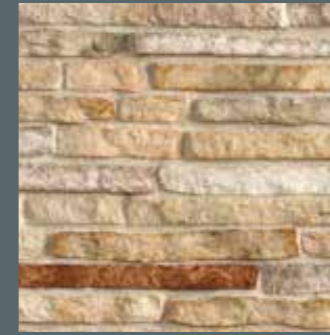

M30

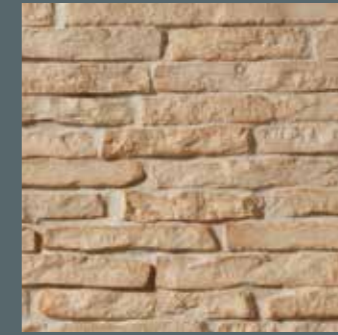

H

## SPECIFICHE / SPECIFICATIONS

Pietra Farnese è realizzata in spessori variabili da 0,8 cm a 2,8 cm.  
*Thickness may vary from  $3/8''$  to  $1 1/8''$ .*

Pietra Farnese viene proposta nelle seguenti altezze approssimative: h 3 - h 7 - h 10.  
*Pietra Farnese is available in the following approximate heights: h  $1 1/5''$  - h  $2 3/4''$  - h  $4''$ .*

Pietra Farnese deve essere posata rispettando scrupolosamente le ISTRUZIONI DI POSA riportate alla fine del presente catalogo.  
*The indicated SETTING INSTRUCTIONS must be carefully observed.*

ATTENZIONE: Tutti i prodotti Decor stone devono essere utilizzati ESCLUSIVAMENTE PER RIVESTIMENTO, in nessun caso possono essere utilizzati per PAVIMENTAZIONI. Essendo i nostri prodotti composti con oltre il 90% di polvere di pietra naturale potrebbero riscontrarsi minime differenze nelle misure e nei toni.

*NOTE: Decor stone products are intended to be used for covering applications only, any flooring setup is strictly prohibited.*

*Being essentially a natural stone product moderate shade and dimension variations could be observed.*

## PEZZI SPECIALI PER ANGOLI / CORNER PIECES

I pezzi speciali per angoli sono forniti a metro lineare e in tutte le varianti di colore / miscele disponibili per i fondi.

*Corner pieces are supplied per linear metre and any indicated shade.*

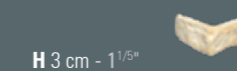

H 3 cm -  $1 1/5''$



H 3 cm -  $1 1/5''$

stone collection **FARNESE XL** pietra



MISCELE COLORI / SHADE BLENDS



M10



M30



H

SPECIFICHE / SPECIFICATIONS

Pietra Farnese XL è realizzata in spessori variabili da 0,8 cm a 2,8 cm.  
*Thickness may vary from 3/8" to 1 1/8".*

Pietra Farnese XL viene proposta in un'unica altezza (approssimativa) di 18 cm.  
*Pietra Farnese XL is uniquely available in the following approximate height: h 7".*

Pietra Farnese XL deve essere posata rispettando scrupolosamente le ISTRUZIONI DI POSA riportate alla fine del presente catalogo.  
*The indicated SETTING INSTRUCTIONS must be carefully observed.*

ATTENZIONE: Tutti i prodotti Decor stone devono essere utilizzati ESCLUSIVAMENTE PER RIVESTIMENTO, in nessun caso possono essere utilizzati per PAVIMENTAZIONI. Essendo i nostri prodotti composti con oltre il 90% di polvere di pietra naturale potrebbero riscontrarsi minime differenze nelle misure e nei toni.

*NOTE: Decor stone products are intended to be used for covering applications only, any flooring setup is strictly prohibited. Being essentially a natural stone product moderate shade and dimension variations could be observed.*

PEZZI SPECIALI PER ANGOLI / CORNER PIECES

I pezzi speciali per angoli sono forniti a metro lineare e in tutte le varianti di colore / miscele disponibili per i fondi.

*Corner pieces are supplied per linear metre and any indicated shade.*

H 18 cm - 7"



H 18 cm - 7"



stone collection  
pietra  
**ROMANA**

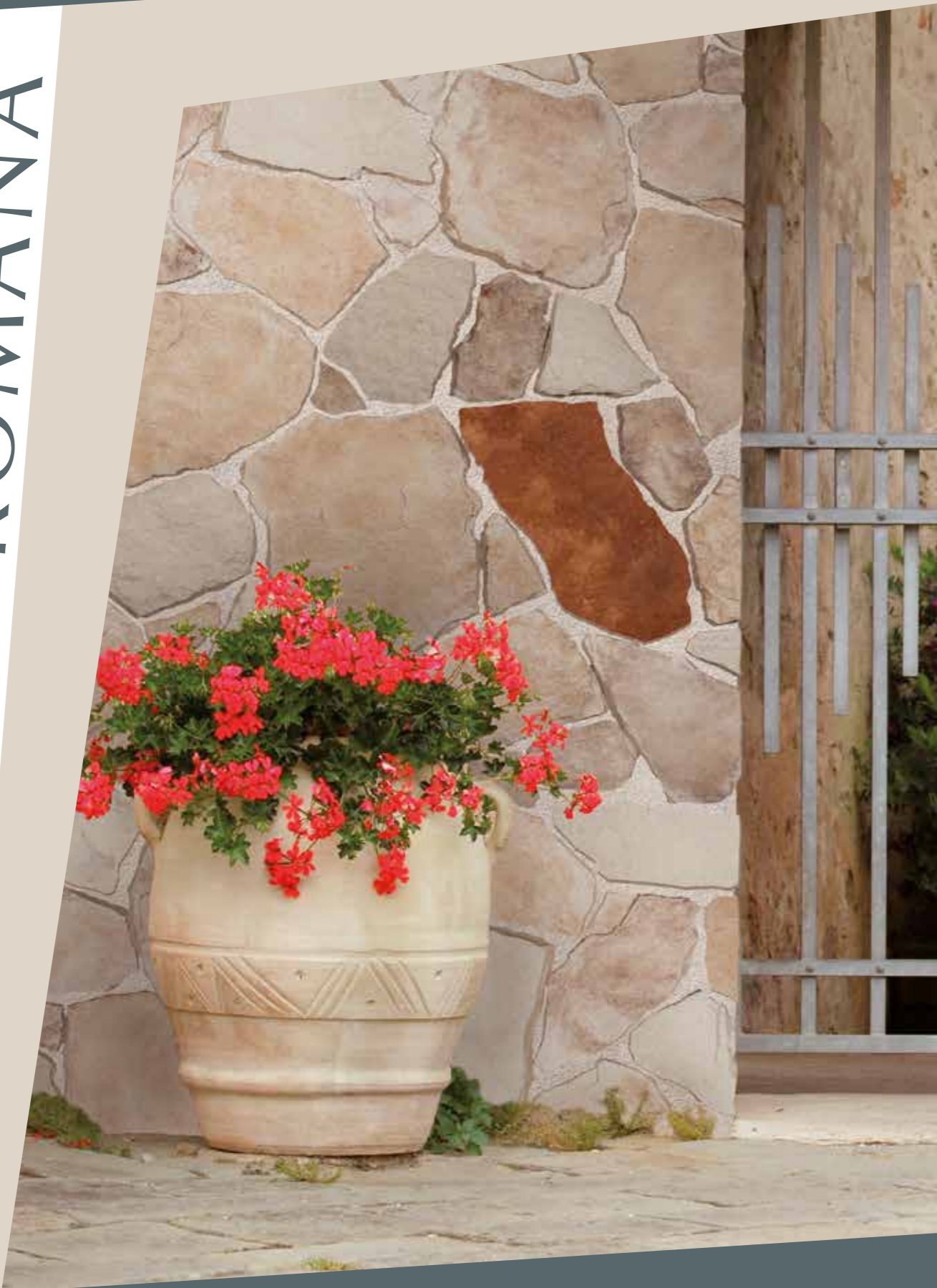

MISCELE COLORI / SHADE BLENDS



M10



M30

SPECIFICHE / SPECIFICATIONS

Pietra Romana è realizzata in spessori variabili da 1,3 cm a 2,5 cm.  
*Thickness may vary from 1/2" to 1".*

Pietra Romana deve essere posata rispettando scrupolosamente le ISTRUZIONI DI POSA riportate alla fine del presente catalogo.  
*The indicated SETTING INSTRUCTIONS must be carefully observed.*

ATTENZIONE: Tutti i prodotti Decor stone devono essere utilizzati ESCLUSIVAMENTE PER RIVESTIMENTO, in nessun caso possono essere utilizzati per PAVIMENTAZIONI. Essendo i nostri prodotti composti con oltre il 90% di polvere di pietra naturale potrebbero riscontrarsi minime differenze nelle misure e nei toni.

*NOTE: Decor stone products are intended to be used for covering applications only, any flooring setup is strictly prohibited. Being essentially a natural stone product moderate shade and dimension variations could be observed.*

PEZZI SPECIALI PER ANGOLI / CORNER PIECES

I pezzi speciali per angoli sono forniti a metro lineare nei formati misti.  
*Corner pieces are supplied in mixed sizes and per linear metre.*



stone collection **pietra LOMBARDA**

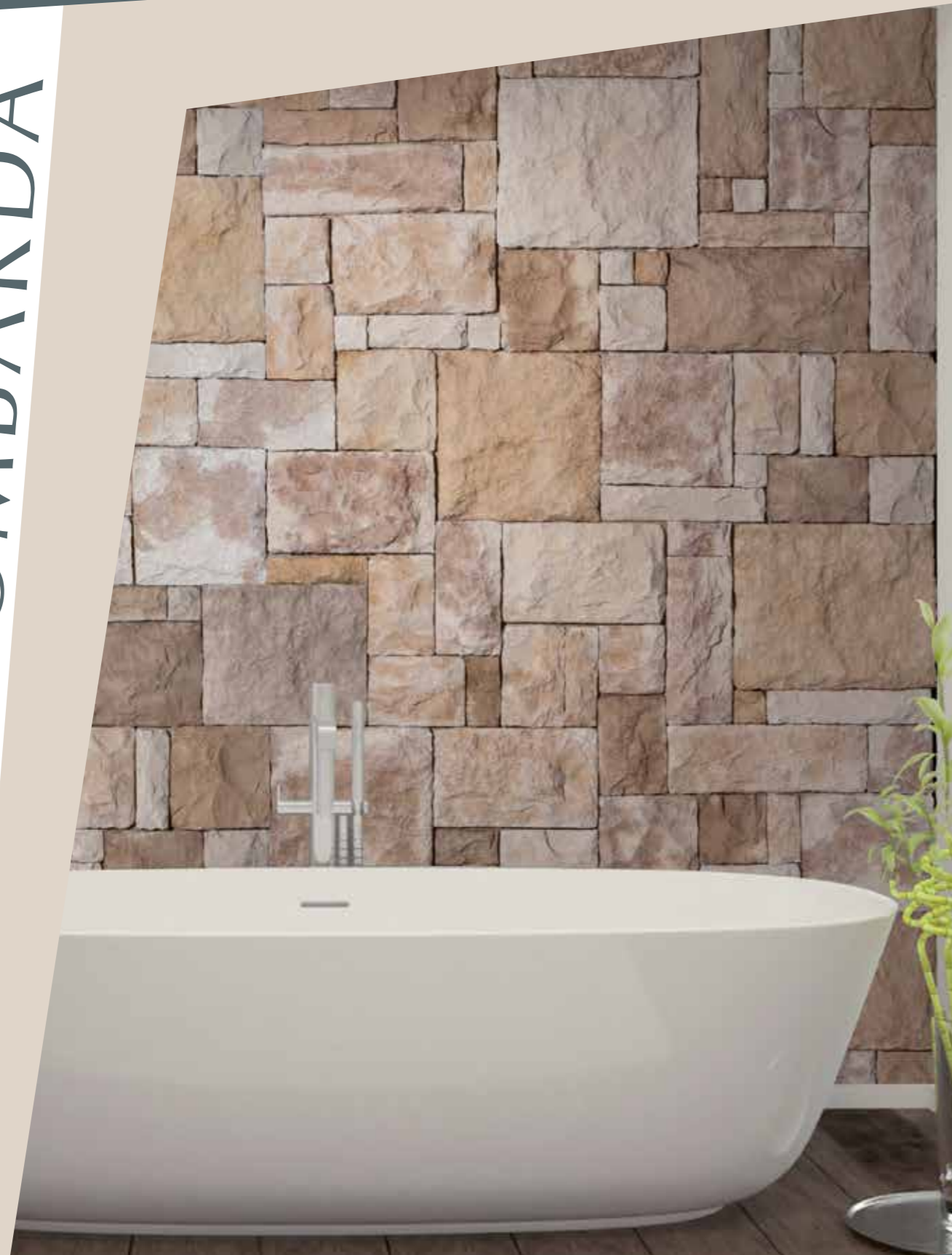

MISCELE COLORI / SHADE BLENDS



M10



M30

SPECIFICHE / SPECIFICATIONS

Pietra Lombarda è realizzata in spessori variabili da 0,8 cm a 2,8 cm.  
*Thickness may vary from 3/8" to 1 1/8".*

Pietra Lombarda deve essere posata rispettando scrupolosamente le ISTRUZIONI DI POSA riportate alla fine del presente catalogo.  
*The indicated SETTING INSTRUCTIONS must be carefully observed.*

ATTENZIONE: Tutti i prodotti Decor stone devono essere utilizzati ESCLUSIVAMENTE PER RIVESTIMENTO, in nessun caso possono essere utilizzati per PAVIMENTAZIONI. Essendo i nostri prodotti composti con oltre il 90% di polvere di pietra naturale potrebbero riscontrarsi minime differenze nelle misure e nei toni.

*NOTE: Decor stone products are intended to be used for covering applications only, any flooring setup is strictly prohibited. Being essentially a natural stone product moderate shade and dimension variations could be observed.*

PEZZI SPECIALI PER ANGOLI / CORNER PIECES



pietra  
**CHIGI**

stone collection

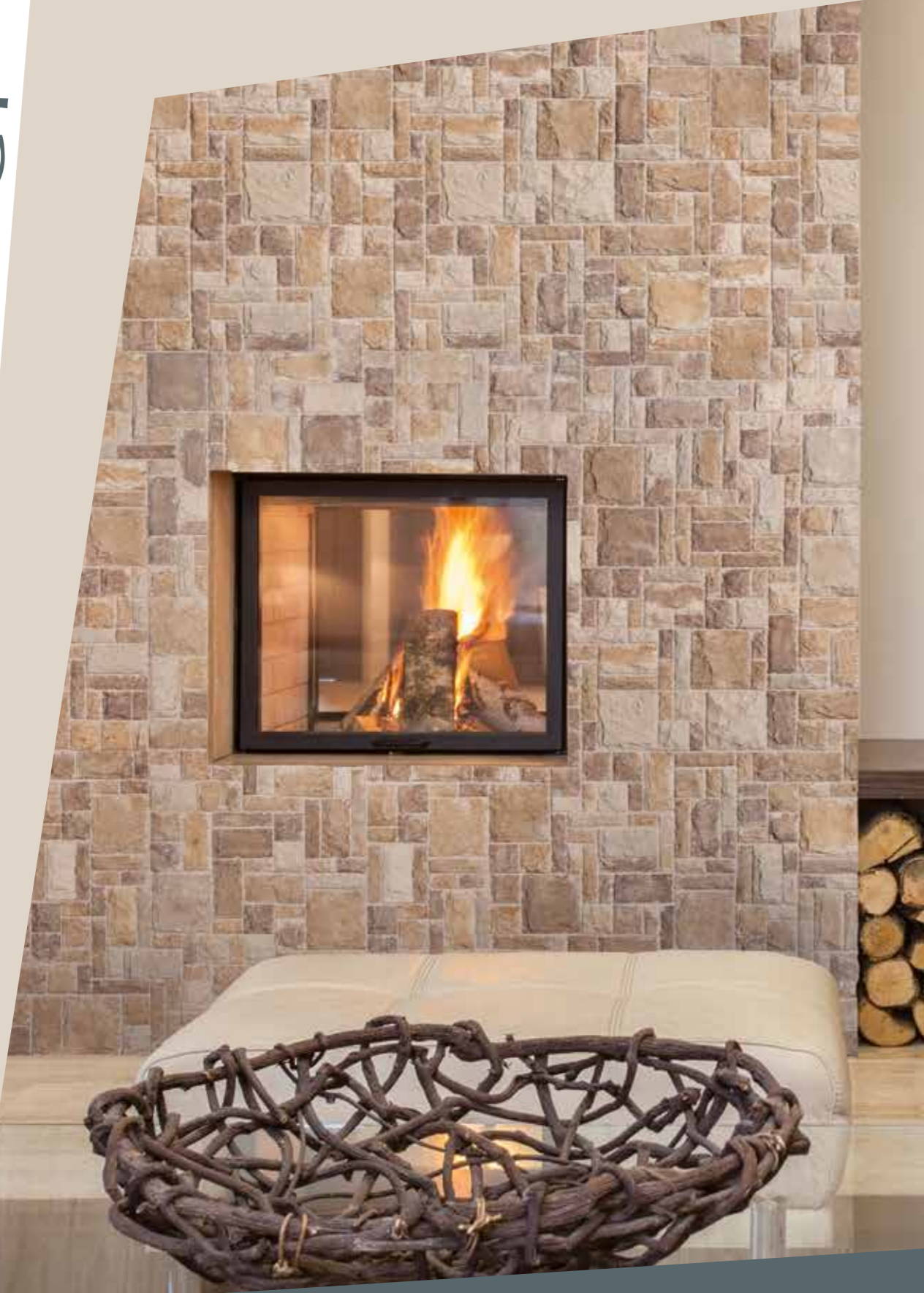

MISCELE COLORI / SHADE BLENDS



M10

SPECIFICHE / SPECIFICATIONS

Pietra Chigi è realizzata in spessori variabili da 0,8 cm a 2,2 cm.  
*Thickness may vary from 3/8" to 7/8".*

Pietra Chigi viene fornita montata su rete nel modulo R04.  
*Pietra Chigi is available mesh-mounted selecting module R04.*

Pietra Chigi deve essere posata rispettando scrupolosamente le ISTRUZIONI DI POSA riportate alla fine del presente catalogo.  
*The indicated SETTING INSTRUCTIONS must be carefully observed.*

ATTENZIONE: Tutti i prodotti Decor stone devono essere utilizzati ESCLUSIVAMENTE PER RIVESTIMENTO, in nessun caso possono essere utilizzati per PAVIMENTAZIONI. Essendo i nostri prodotti composti con oltre il 90% di polvere di pietra naturale potrebbero riscontrarsi minime differenze nelle misure e nei toni.

*NOTE: Decor stone products are intended to be used for covering applications only, any flooring setup is strictly prohibited. Being essentially a natural stone product moderate shade and dimension variations could be observed.*

PEZZI SPECIALI PER ANGOLI / CORNER PIECES

I pezzi speciali per angoli sono forniti a metro lineare nei formati misti.  
*Corner pieces are supplied in mixed sizes and per linear metre.*

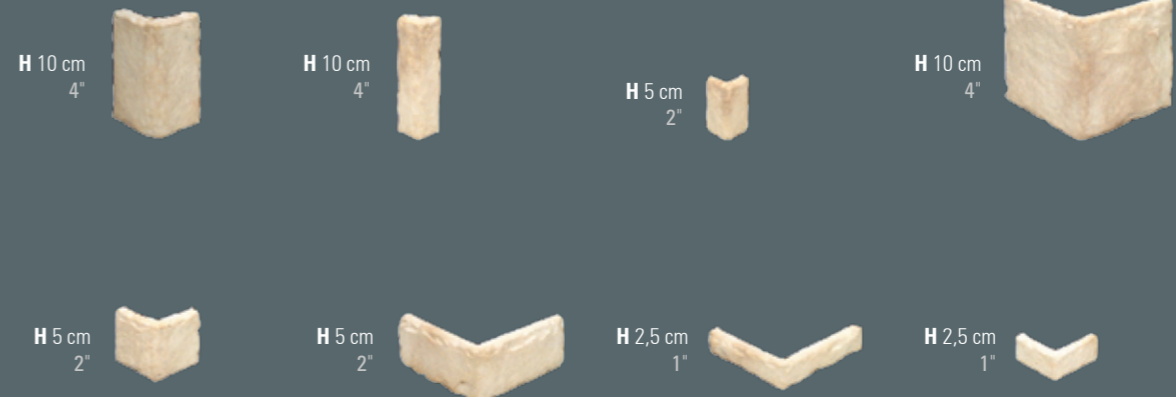



## Pezzi speciali per archi / SPECIAL ARCH PIECES



PE 30 01

PE 30 02

PE 30 03

PE 30 04

PE 30 05

### colore / SHADE

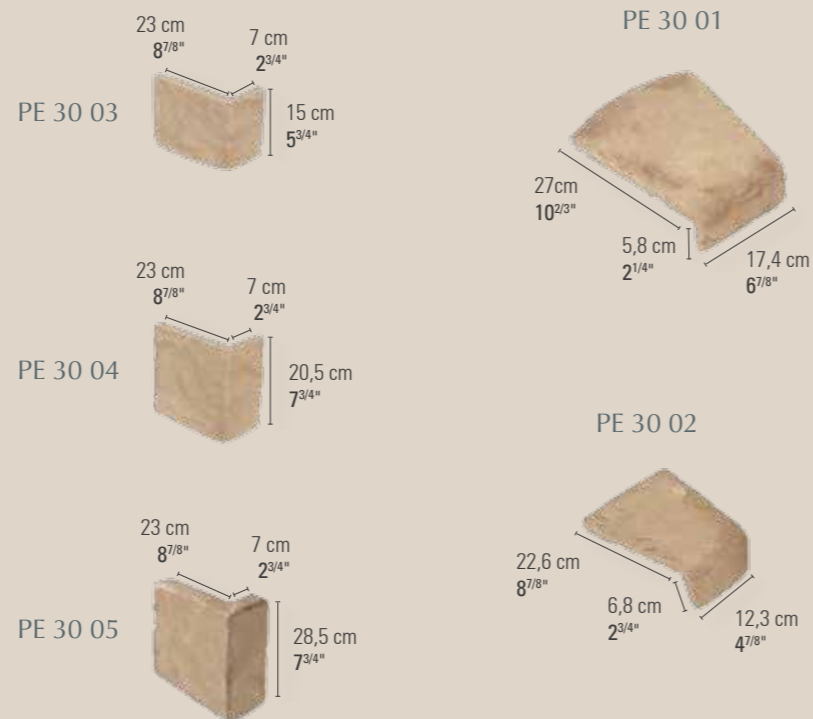
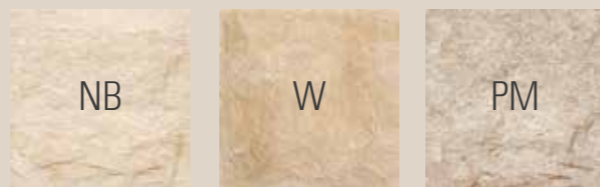

## Lavabo Petra / WASHBASIN



### 16 PS 01 LAVABO PETRA

62,5X44 CM. X16,5 H.  
243/5"X171/3" X61/2" H.  
KG. 41,00 - LBS. 90,00



### Colori / SHADES



16 PS 01 LAVABO + 19 F16 MOBILE PETRA

## Lavello Roccia / SINK



### 16 PS 02 LAVELLO ROCCIA

69X49 CM. X18 H.  
281/5"X20"X71/8" H.  
KG. 55,00 - LBS. 120,00

### Colori / SHADES

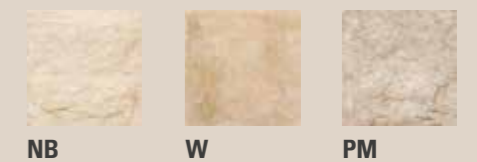

stone collection **ORSINI** pietra

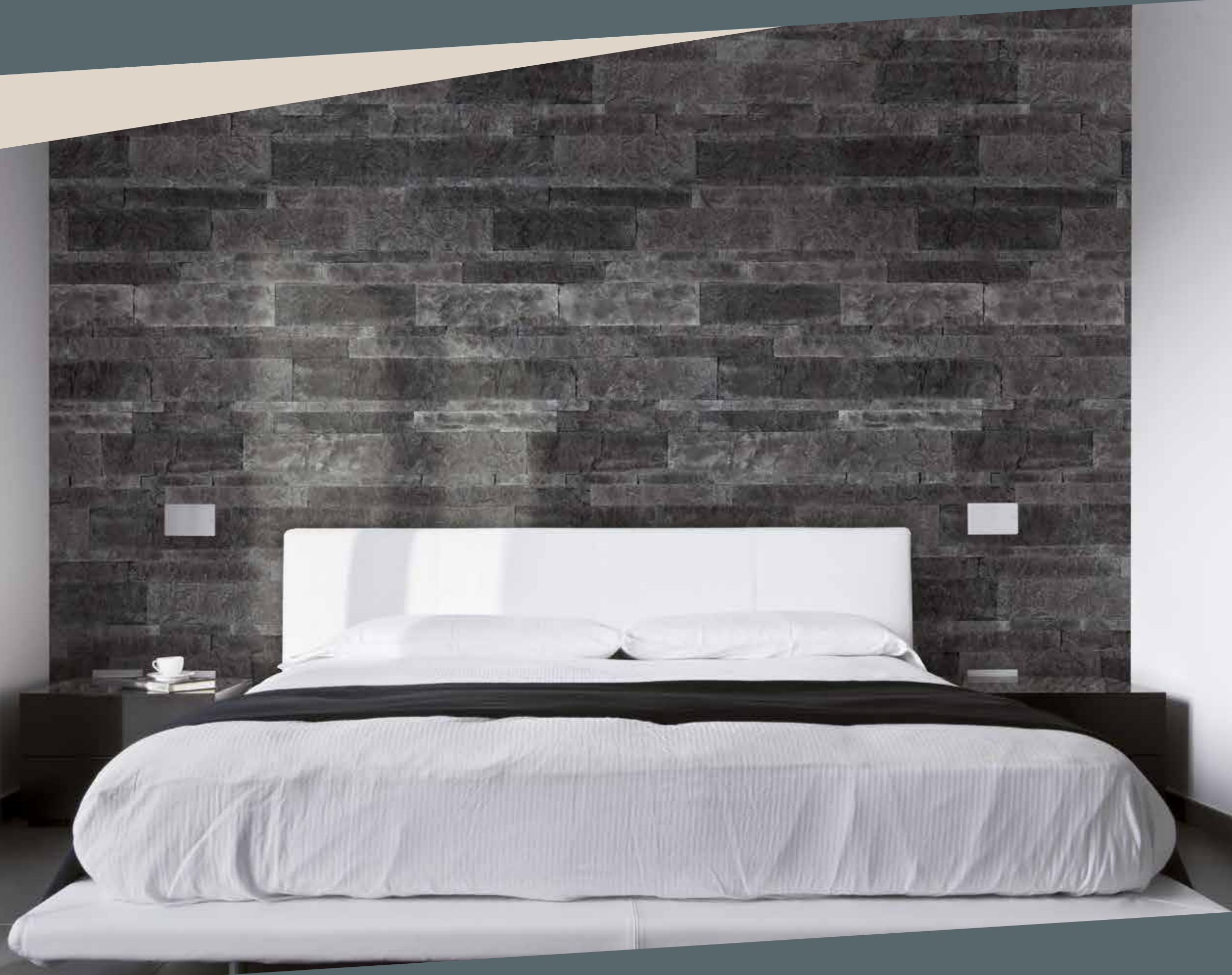

PE26 -27-28 M50

## FORMATI / SIZES

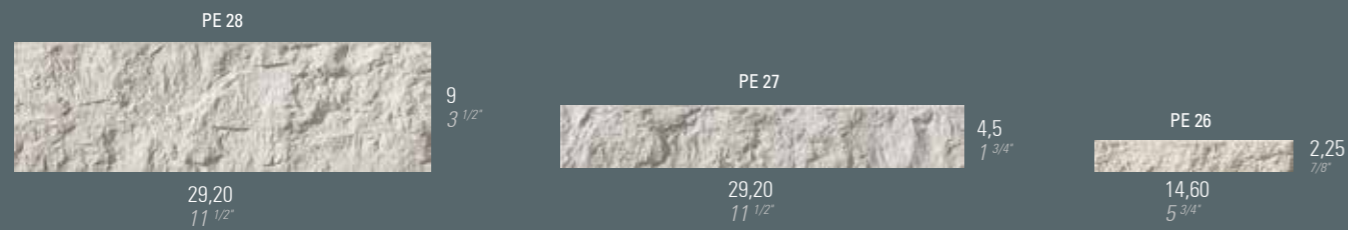

## MODULO SU RETE / MESH MOUNTED MODULE

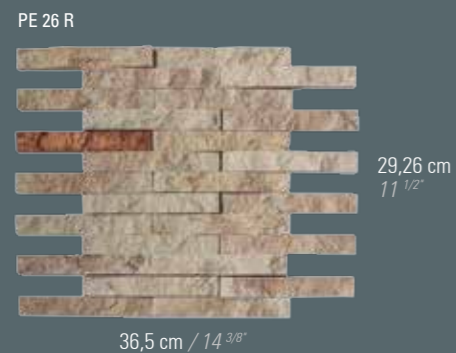

## COLORI / SHADES



## MISCELE COLORI / SHADE BLENDS



## SPECIFICHE / SPECIFICATIONS

Pietra Orsini è realizzata in spessori variabili da 0,8 cm a 2,8 cm.  
 Thickness may vary from  $3/8''$  to  $1 1/8''$ .

Pietra Orsini deve essere posata rispettando scrupolosamente le ISTRUZIONI DI POSA riportate alla fine del presente catalogo.  
 The indicated *SETTING INSTRUCTIONS* must be carefully observed.

ATTENZIONE: Tutti i prodotti Decor stone devono essere utilizzati ESCLUSIVAMENTE PER RIVESTIMENTO, in nessun caso possono essere utilizzati per PAVIMENTAZIONI. Essendo i nostri prodotti composti con oltre il 90% di polvere di pietra naturale potrebbero riscontrarsi minime differenze nelle misure e nei toni. Possono verificarsi nel corso del tempo lievi stonalizzazioni sul tono T dovute al naturale ingiallimento della polvere di marmo carrara contenuta all'interno.

NOTE: Decor stone products are intended to be used for covering applications only, any flooring setup is strictly prohibited. Slight yellow shade variations could be observed on "T" tones due to the natural ageing of Carrara marble dust in the engineered stone composition. Being essentially a natural stone product moderate shade and dimension variations could be observed.

## PEZZI SPECIALI PER ANGOLI / CORNER PIECES

I pezzi speciali per angoli sono forniti a metro lineare e in tutte le varianti di colore / miscele disponibili per i fondi.  
 Corner pieces are supplied per linear metre and any indicated shade.



modern collection **ARDESIA**

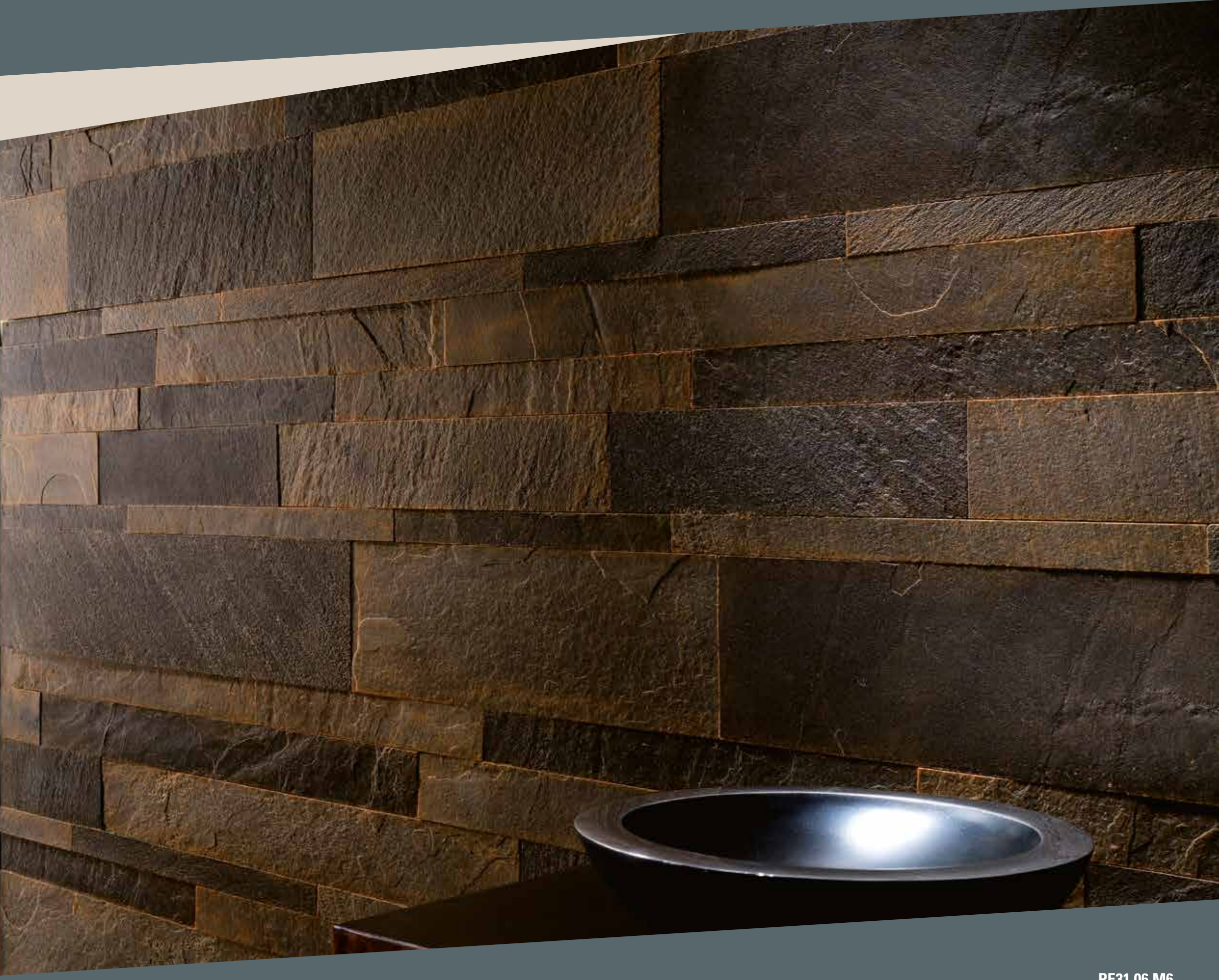

PE31 06 M6

## SPECIFICHE / SPECIFICATIONS

Ardesia è realizzata in spessori variabili da 1,2 cm a 1,6 cm.  
*Thickness may vary from 1/2" to 5/8".*

## MISCELE COLORI / SHADE BLENDS

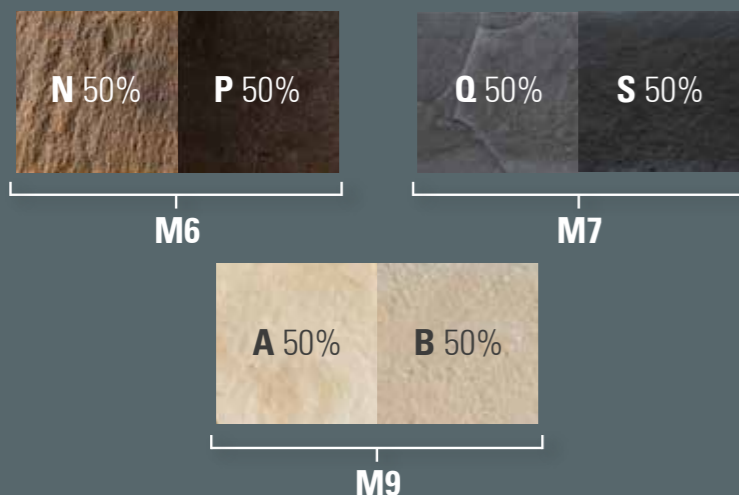

## COLORI / SHADES

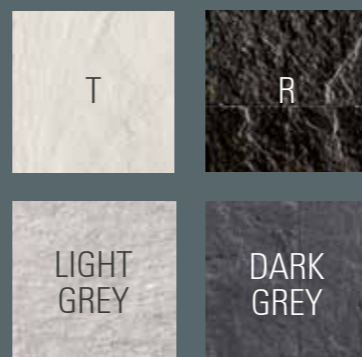

I Codici PE 31...si riferiscono alla finitura Natural, mentre i Codici PB 31...si riferiscono alla finitura Brushed.

*PE31.. item codes refer to the "natural" finish while PB31.. item codes to the "brushed" finish.*

Ardesia deve essere posata rispettando scrupolosamente le ISTRUZIONI DI POSA riportate alla fine del presente catalogo.

*The indicated SETTING INSTRUCTIONS must be carefully observed.*

**ATTENZIONE:** Tutti i prodotti Decor stone devono essere utilizzati **ESCLUSIVAMENTE PER RIVESTIMENTO**, in nessun caso possono essere utilizzati per PAVIMENTAZIONI. Essendo i nostri prodotti composti con oltre il 90% di polvere di pietra naturale potrebbero riscontrarsi minime differenze nelle misure e nei toni. Possono verificarsi nel corso del tempo lievi stonalizzazioni sul tono T dovute al naturale ingiallimento della polvere di marmo carrara contenuta all'interno.

*NOTE: Decor stone products are intended to be used for covering applications only, any flooring setup is strictly prohibited. Slight yellow shade variations could be observed on "T" tones due to the natural ageing of Carrara marble dust in the engineered stone composition. Being essentially a natural stone product moderate shade and dimension variations could be observed.*

## PEZZI SPECIALI PER ANGOLI / CORNER PIECES

I pezzi speciali per angoli sono forniti a metro lineare miscelati nelle varie altezze, forme e tipologie, nonché in tutte le varianti di colore /miscele disponibili per i fondi.

*Corner pieces are supplied per linear metre blended in height, shape and type available in any indicated shade.*

## FORMATI / SIZES

### PE 31 01

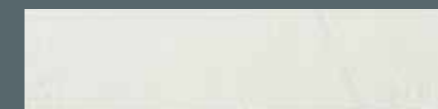

H 14 cm / 5 1/2" L 60 cm / 23 5/8"

### PE 31 02

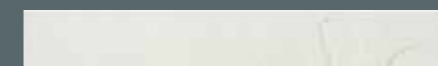

H 8 cm / 3 1/8" L 60 cm / 23 5/8"

### PE 31 03



H 6 cm / 2 3/8" L 60 cm / 23 5/8"

### PE 31 04



H 4,5 cm / 1 3/4" L 60 cm / 23 5/8"

### PE 31 05

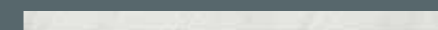

H 3 cm / 1 1/8" L 60 cm / 23 5/8"

## MODULO SU RETE / MESH MOUNTED MODULE

### PE 31 12

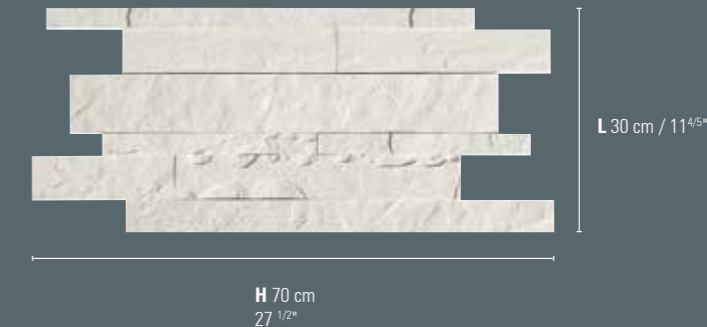

### SET ANGOLI SU RETE / MESH MOUNTED CORNER PIECES

H 3 / 1 1/8"	H 4,5 / 1 3/4"	H 6 / 2 3/8"	H 8 / 3 1/8"
14,8x6,6	14x11,3	16,9x5,3	12,1x9,8
14,4x7,8	17,3x4,8	17,2x4,8	

### SET ANGOLI SFUSI / AVAILABLE CORNER PIECES

H 3 / 1 1/8"	H 4,5 / 1 3/4"	H 6 / 2 3/8"	H 8 / 3 1/8"	H 14 / 5 1/2"
2,6x2,4	3,3x3	2,1x2,8	3,3x2,3	12,7x3,7
2,7x1,6	3,8x1,7	3,5x2	7,1x4,6	11,8x4,2
2,9x2,1	3,6x3	4,3x2,1	5,4x4,4	8,2x8
3,5x1,7	5,1x4,8	5,5x3,6	10,1x6,2	9x6,9
3,1x2,6	5,3x3,6	7,3x2,9	5x9,6	8,4x6,1
3,6x3	6,9x3	7,3x4	12,9x3	10x10,1
4,1x3,8	8,1x1,7	8x7,6	13,1x5	
4,4x2,6	8,3x2			
4,3x3,6				
4,6x2,8				
4x4,5				
5,6x2,1				

modern collection ARDESIA XL



## SPECIFICHE / SPECIFICATIONS

Ardesia XL è realizzata in spessori variabili da 1,2 cm a 1,6 cm.  
*Thickness may vary from 1/2" to 5/8".*

## COLORI / SHADES

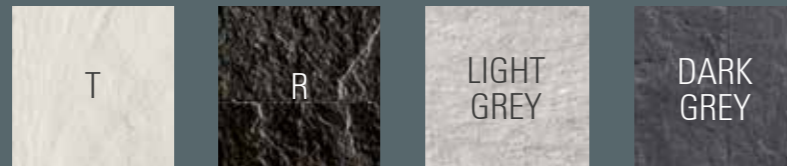

I Codici PE 31...si riferiscono alla finitura Natural, mentre i Codici PB 31...si riferiscono alla finitura Brushed.

*PE31.. item codes refer to the "natural" finish while PB31.. item codes to the "brushed" finish.*

Ardesia deve essere posata rispettando scrupolosamente le ISTRUZIONI DI POSA riportate alla fine del presente catalogo.

*The indicated SETTING INSTRUCTIONS must be carefully observed.*

ATTENZIONE: Tutti i prodotti Decor Stone devono essere utilizzati ESCLUSIVAMENTE PER RIVESTIMENTO, in nessun caso possono essere utilizzati per PAVIMENTAZIONI. Essendo i nostri prodotti composti con oltre il 90% di polvere di pietra naturale potrebbero riscontrarsi minime differenze nelle misure e nei toni. Possono verificarsi nel corso del tempo lievi stonalizzazioni sul tono T dovute al naturale ingiallimento della polvere di marmo carrara contenuta all'interno.

*NOTE: Decor Stone products are intended to be used for covering applications only, any flooring setup is strictly prohibited. Slight yellow shade variations could be observed on "T" tones due to the natural ageing of Carrara marble dust in the engineered stone composition. Being essentially a natural stone product moderate shade and dimension variations could be observed.*

## PEZZI SPECIALI PER ANGOLI / CORNER PIECES

I pezzi speciali per angoli sono forniti al pezzo, in tutte le varianti di colore.  
*Corner are supplied per piece in any available shade.*

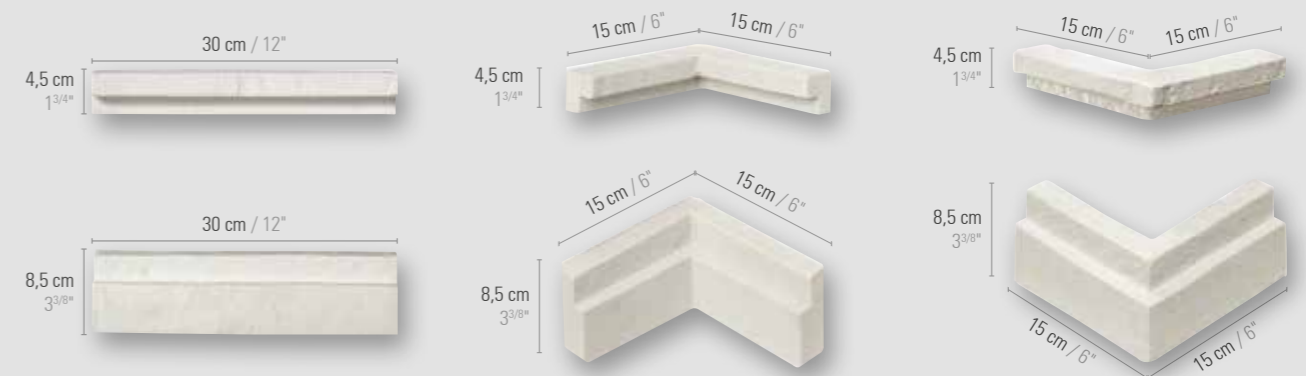

modern collection **HEXAGON**

by Giovanni Barberi



FINITURA / TEXTURE

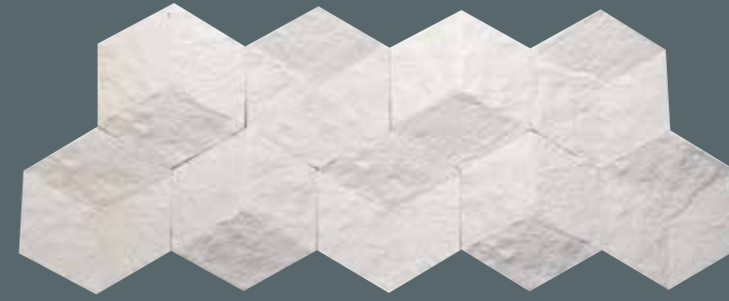

Rock GB 09

COLORI / SHADES



Travertino Light Grey

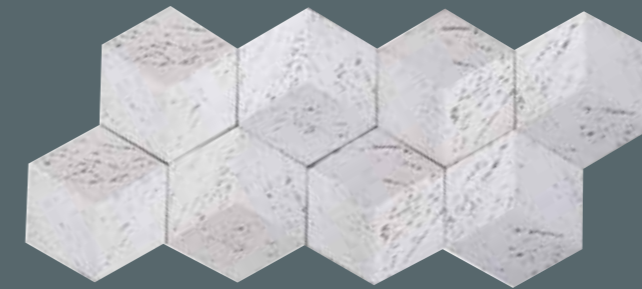

Travertino GB 08

COLORI / SHADES



Travertino Light Grey

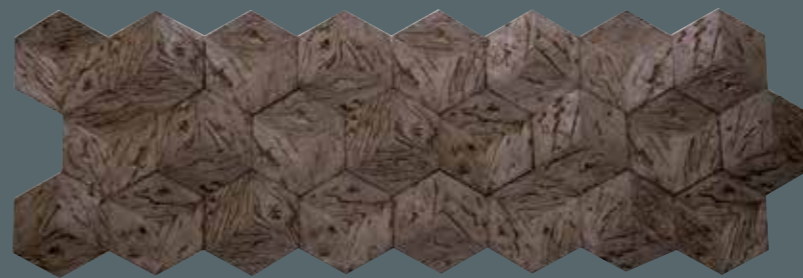

Wood GB 10

COLORI / SHADES



Old Barn White

FORMATO / SIZE

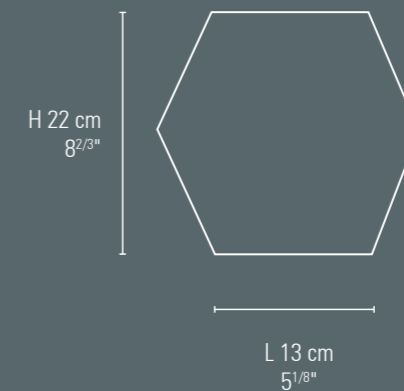

GB 09 TRAVERTINO



# BOREAL

by Giovanni Barberi

modern collection



GB 05 WHITE

COLORI / SHADES



White

Jasmine

Brown

Light Grey

Dark Grey

DIMENSIONI / SIZES

60x60 cm - 23<sup>5</sup>/<sub>8</sub>" x 23<sup>5</sup>/<sub>8</sub>"

# SHADES

by Giovanni Barberi

modern collection



GB 02 BROWN

COLORI / SHADES



White

Jasmine

Brown

Light Grey

Dark Grey

DIMENSIONI / SIZES

60x60 cm - 23<sup>5</sup>/<sub>8</sub>" x 23<sup>5</sup>/<sub>8</sub>"

modern collection **WOOD SERIES** antique



PE45 R 02 CHESTNUT

FORMATI / SIZES

PE 45 01



H 12 cm / 4" L 60 cm / 23 5/8"

PE 45 02



H 6 cm / 2 3/8" L 60 cm / 23 5/8"

PE 45 03



H 3 cm / 1 1/5" L 60 cm / 23 5/8"

COLORI / SHADES



Chestnut



Durmast



Old Barn

MODULO SU RETE / ON MESH



H 70 cm / 27 1/2"

modern collection **RINEMI** by Giovanni Barbieri



GB 03 DARK GREY

DIMENSIONI / SIZES

55x60 cm - 21" x 23 5/8"

COLORI / SHADES

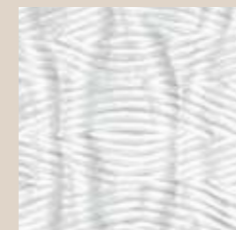

White

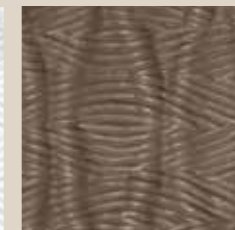

Beige

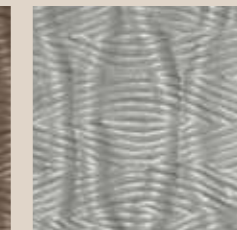

Light Grey

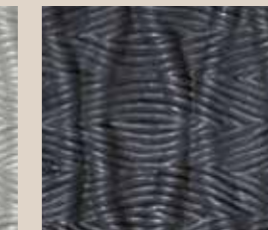

Dark Grey

modern collection **SHADOW SERIES**

by Giovanni Barbieri



PE 47 R 02 BROWN

MODULO SU RETE / ON MESH



COLORI / SHADES



White Jasmine Brown Light Grey Dark Grey

modern collection **SOLID MARBLE**

by Giovanni Barbieri



GB 11 R 01 U

MODULO SU RETE / ON MESH

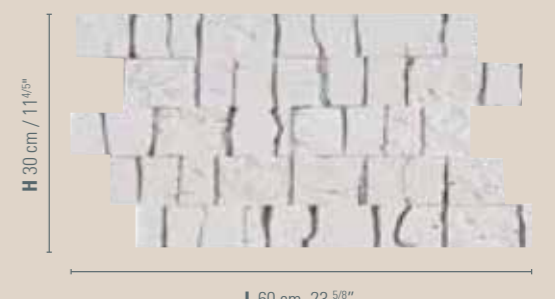

COLORI / SHADES



U Light Grey Dark Grey

# Listelli / Trims



# Arredo / Furniture



Il catalogo Listelli e Arredamento è disponibile su:  
[www.decorstonesrl.com/general2016.pdf](http://www.decorstonesrl.com/general2016.pdf)

The trims and furniture catalog is available at:  
[www.decorstonesrl.com/general2016.pdf](http://www.decorstonesrl.com/general2016.pdf)

# Tecnologia / Technology

La costante ricerca della qualità è alla base della strategia della Tecno Art Marmi ed abbraccia tutto il sistema aziendale. Decor Stone ha infatti scelto di certificare il proprio sistema qualità secondo la norma UNI EN ISO 9001. Decor Stone sottopone inoltre i prodotti ai test ed alle certificazioni degli organismi preposti, secondo quanto previsto dalle norme nazionali ed internazionali. Tecno Art Marmi garantisce i suoi prodotti per resistenza al gelo, alla luce, ad agenti chimici domestici e additivi per piscina, ignifughi.

The ongoing quest for quality is at the core of Decor Stone's strategy embracing the entire company's system. Decor Stone has chosen to certify its quality system according to UNI EN ISO 9001 standards. Products have been tested and certified by registered institutes following national and international requirements. Products are guaranteed to be frost proof as well as resistant to fire, domestic chemical agents and swimming pool additives.

La stratégie de Decor Stone se base sur la recherche constante de la qualité, qui concerne tout le système de l'entreprise. Decor Stone a choisi de certifier son système qualité conformément à la norme UNI EN ISO 9001. De plus, Decor Stone soumet ses produits aux essais et aux certifications des organes préposés, selon les prescriptions des normes nationales et internationales. Decor Stone garantit des produits ignifuges, qui résistent également au gel, à la lumière, aux agents chimiques domestiques et aux additifs pour piscines.

Das konstante Streben nach Qualität ist das Grundprinzip von Decor Stone und erstreckt sich über das gesamte Firmensystem. Deshalb hat sich die Firma entschlossen, das eigene Qualitätssystem nach der Norm UNI EN ISO 9001 zu zertifizieren. Außerdem unterzieht Decor Stone ihre Produkte den Tests und Zertifizierungen leitender Organe gemäß den Anforderungen nationaler und internationaler Bestimmungen. Die Produkte von Decor Stone sind garantiert beständig gegen Frost, Licht, Feuer, Haushaltschemikalien und Zusätze für Schwimmbekken.

La constante búsqueda de la calidad es la base de la estrategia Decor Stone y abarca todo el sistema empresarial. En efecto, Decor Stone ha elegido certificar su sistema de calidad según la norma UNI EN ISO 9001. Decor Stone somete a sus productos a las pruebas y certificaciones de los específicos organismos, según lo establecido por las normas nacionales e internacionales. Decor Stone garantiza sus productos por lo que se refiere a la resistencia a las heladas, a la luz, a agentes químicos domésticos y a adit vos para piscina, siendo asimismo ignífugos.



Постоянное усовершенствование уровня качества продукции лежит в основе политики TAM и охватывает все сферы деятельности компании. Decor Stone сертифицирует качество своей продукции в соответствии со стандартами UNI EN ISO 9001. Продукция проходит тестирование и сертификацию в специализированных институтах, соответствующих национальным и международным стандартам. Decor Stone гарантирует качество продукции и воздействие на нее холода, света, абразивных и химических средств, хлорки и огня.

البحث المستمر عن الجودة هو أساس سياسة تكنو آرت مرمي ويعانق كافة نظام العمل في الشركة. في الواقع تكنو آرت مرمي اختارت إصدار شهادات جودة خاصة بما حسب مواصفات UNI EN ISO 9001. تكنو آرت مرمي علاوة على ذلك تضع منتجاتها تحت اختبار وشهادة المبيعات المختصة، تماشياً مع ما تنص عليه المواصفات الوطنية والعالمية. تكنو آرت مرمي تضمن منتجاتها لمقاومة الصقيع، الضوء، إلى المواد الكيميائية المنزلية، والمواد التي تضاف في برك السباحة؛ المنتجات غير قابلة للاشتعال.

<b>RISULTATI DEI TEST</b> Test results • Résultats des tests Testergebnisse • Resultados de las pruebas Технические характеристики	<b>ASTM TEST</b>	<b>RICHIESTO</b> Required • Requis Nötig • Valor Requerido Требуемые показатели Компания	<b>DECOR STONE</b>
<b>Assorbimento</b> Absorption by weight % • Absorption Absorption • Absorbencia Коэффициент водопоглощения	C97	0,2% Max	0,17
<b>Peso specifico volume e densità</b> Density & bulk specific gravity • Poids spécifique, volume et densité Specifisches Gewicht, Volumen und Dichte • Peso específico volumen y densidad Плотность и объем силы тяжести	C97	2595 Kg/m3	2583 Kg/m3
<b>Modulo di rottura</b> Rupture modulus • Module de ropture Bruchmodul • Modulo de ruptura Устойчивость к излому	C99	7 MPa MIN	16,1 MPa
<b>Resistenza alla compressione</b> Compressive strength • Résistance à la compression Druckfestigkeit • Resistencia a la compresión Устойчивость к давлению	C170	52MPa MIN	76,2 MPa
<b>Indice di abrasione</b> Abrasion index • Index de l'écorchure Reibindex • Indice de abrasión Коэффициент истираемости	C241	10,00	9,2
<b>Durezza</b> Knoop hardness • Dureté Härtezahl • Durezza Твердость	C849	1280 Mpa	259 Mpa
<b>Resistenza alla flessione</b> Flexural strength • Résistance à la flexion Biegefestigkeit • Resistencia a la flexión Устойчивость на изгибание	C880	7 MPa MIN	16,6 MPa
<b>Resistenza alla corrosione salina con SO2 (PH&lt;3)</b> Resistance to salt corrosion using SO2 (PH<3) • Résistance à l'érosion avec SO2 (PH<3) Korrosionfestigkeit mit SO2 (PH<3) • Resistencia a la corrosión salina SO2 (PH<3) Устойчивость к разъеданию соли с SO2 (ph < 3)	Din 50021 class	-	<b>Positivo</b> Positively passed Positif • Positiv • Positivo Положительный результат
<b>Resistenza alla erosione chimico-fisica</b> Ageing due to chemical-physical erosion Résistance à l'érosion chimique- physique Chemisch-physische Erosionfestigkeit Resistencia a la erosiónquímico-física Устойчивость к эрозии материала путем химических и физических воздействий	NF T30 049	-	<b>Positivo</b> Positively passed Positif • Positiv • Positivo Положительный результат

Il materiale ricomposto mostra un'ottima resistenza alle fiamme in quanto la propagazione di queste non dura a lungo ed il fuoco si spegne immediatamente. Durante il test non si è verificata alcuna particolare alterazione del materiale.

Composite material shows very good behavior to flame resistance as surface propagation does not last and suddenly stops. No specimen change is observed other than black smoke during the test.

Le matériel reconstitué a une résistance excellente aux flammes puisque la propagation de celles-ci ne persiste pas longtemps et le feu s'éteint tout de suite. Le matériel n'a subit aucune altération particulière pendant le test.

Das agglomerate Material hat einen ausgezeichneten Widerstand gegen den Flammen, dessen Verteilung nicht lange dauert. Das Feuer verlöscht sofort. Während des Test hat das Material keine besondere Modification bemerkt.

El material recompuesto muestra óptima resistencia a las llamas porquè la propagación de las mismas no dura mucho tiempo y el fuego se apaga inmediatamente. Durante el test no se hanotado ninguna particular alteración del material.

Материал из которого выполнена продукция обладает высокой термостойкостью, не меняет своих свойств и внешний вид при прямом воздействии огня

## ISTRUZIONI DI POSA

Per la posa in opera in condizioni di NORMALE UTILIZZO dovranno essere rispettate RIGOROSAMENTE le seguenti istruzioni:

### COLLANTI

**Collanti da utilizzare per prodotti appartenenti alle serie: PIETRA LOMBARDA - PIETRA FARNESE - PIETRA FARNESE XL PIETRA CHIGI - PIETRA ROMANA - PIETRA ORSINI**

#### USO INTERNO:

KERAKOLL H40 NO LIMITS oppure MAPEI ULTRALITE S2.

#### USO ESTERNO:

KERAKOLL SUPERFLEX ECO oppure MAPEI KERAKASTIC T oppure BENFER BENFERIOLLY.

#### CASI PARTICOLARI:

Per utilizzi particolari come rivestimento doccia, rivestimento pareti cartongesso, rivestimento camini e per altezze superiori a 3 ml, è d'obbligo posare con KERAKOLL SUPERFLEX ECO oppure MAPEI KERALASTIC T oppure BENFER BENFERIOLLY.

**Collanti da utilizzare per prodotti appartenenti alle serie: ARDESIA - ARDESIA XL - SNAKE - SERIE 3D**

#### USO INTERNO ED ESTERNO:

KERAKOLL SUPERFLEX ECO oppure MAPEI KERALASTIC T oppure BENFER BENFERIOLLY.

#### Applicazione:

Durante la posa prelevare contemporaneamente le pietre o i listelli da diverse scatole avendo l'accortezza di miscelare varie forme e sfumature evitando di creare ripetizioni. Applicare il collante specifico sulla parete da rivestire e sui singoli pezzi (doppia spalmatura). Posare il materiale partendo dal basso e dagli angoli, qualora previsti, facendo aderire le pietre con un movimento dall'alto al basso e viceversa, affinché la colla si stenda uniformemente. Eventuali residui di colla vanno asportati in giornata con spatola o spugna completamente asciutte.

### STUCCATURA

#### Prodotti da utilizzare per esterno:

KERAKOLL BIOCALCE PIETRA da utilizzare secondo le specifiche tecniche KERAKOLL MAPEI MAPE-ANTIQUÉ da utilizzare secondo le specifiche tecniche MAPEI

#### Prodotti da utilizzare per interno:

KERAKOLL FUGABELLA 2-12 da utilizzare secondo le specifiche tecniche KERAKOLL MAPEI ULTRA COLOR da utilizzare secondo le specifiche tecniche MAPEI

## SETTING INSTRUCTIONS

Under standard installation conditions the following instructions must be CAREFULLY observed:

### ADHESIVES

PIETRA LOMBARDA - PIETRA FARNESE - PIETRA FARNESE XL  
PIETRA CHIGI - PIETRA ROMANA - PIETRA ORSINI

INTERIOR APPLICATIONS:

KERAKOLL H40 NO LIMITS or MAPEI ULTRALITE S2.

EXTERIOR APPLICATIONS:

KERAKOLL SUPERFLEX ECO, MAPEI KERALASTIC T or BENFER BENFERIOLLY.

SPECIFIC APPLICATIONS:

KERAKOLL SUPERFLEX ECO, MAPEI KERALASTIC T or BENFER BENFERIOLLY adhesives should be used for shower, plasterboard, fireplace surroundings and installation heights exceeding 3 metres.

Recommended adhesives for:

ARDESIA - ARDESIA XL - SNAKE - 3D SERIES

INTERIOR AND EXTERIOR APPLICATIONS:

KERAKOLL SUPERFLEX ECO, MAPEI KERALASTIC T or BENFER BENFERIOLLY.

#### Use:

During preliminary installation pieces must be selected simultaneously from different boxes. The adhesive should be applied both on the piece and installation surface (double-spreading technique).

Application should begin from below and the corner profiles applying forward/reverse motion achieving a uniform setting, any excess adhesive should be removed using a dry spatula or sponge.

### GROUTING

Exterior applications:

KERAKOLL BIOCALCE PIETRA to be applied following the manufacturer's technical specifications.

MAPEI MAPE-ANTIQUÉ to be applied following the manufacturer's technical specifications.

Interior applications:

KERAKOLL FUGABELLA 2-12 to be applied following the manufacturer's technical specifications.

MAPEI ULTRA COLOR to be applied following the manufacturer's technical specifications.

#### Applicazione:

Dopo aver realizzato l'impasto versare il prodotto nel SAC A POCHE per agevolare l'applicazione dello stucco. Applicare l'impasto tra un pezzo e l'altro di materiale facendo pressione sulla superficie in modo che lo stucco riempra perfettamente ogni spazio vuoto. Attendere fino a quando la stuccatura risulti consistente ma ancora umida (30 minuti circa). Passare sulle stuccature con il manico di un pennello per rimuovere lo stucco in eccesso. Ripassare sulle stuccature con le setole del pennello per rendere le fughe più lisce ed uniformi. Rimuovere immediatamente ogni residuo di stucco dal materiale posato mediante la spazzola di saggina asciutta. Eventuali residui presenti dopo 24 ore dalla stuccatura potranno essere rimossi mediante l'uso di prodotti a base acida come KERAKOLL DELTAPLUS o MAPEI KERANET, diluiti con acqua in rapporto di 1:1.

### AVVERTENZE

Petra Stone è un prodotto che deve essere utilizzato esclusivamente per rivestimento. L'uso di collanti diversi da quelli indicati nelle istruzioni di posa può provocare il distacco del materiale, così come l'utilizzo con temperature inferiori a 5° C. o superiori a 25° C. in quest'ultimo caso bagnare abbondantemente la superficie di posa, posando successivamente il materiale senza la presenza di velo d'acqua. Non posare su superfici in presenza di vernice o disarmante. Non posare su intonaci indeboliti dall'umidità e dal tempo. Non posare su malta fine o finiture a base di calce di scarsa consistenza o in presenza di polveri. Pareti soggette ad elevate fonti di calore devono essere isolate preventivamente. Realizzare giunti elastici di dilatazione ogni 10 m² all'esterno, ogni 25 m² all'interno, ogni 8 m. di lunghezza per superfici lunghe e strette. Rispettare tutti i giunti strutturali, di frazionamento e perimetrali già presenti sulla superficie da rivestire.

I collanti e le modalità di posa riportati sui nostri documenti ufficiali si riferiscono ad applicazioni su superfici di normale utilizzo in ambienti interni/esterni, non sottoposti a particolari condizioni che non rientrano nei parametri di normalità costruttiva. Per applicazioni diverse da quelle di cui sopra è fatto obbligo consultare l'Azienda per iscritto in modo da poter ricevere adeguate istruzioni al tipo di utilizzo o supporto.

**L'AZIENDA DECLINA OGNI RESPONSABILITA' SE NON INTERPELLATA PREVENTIVAMENTE PER TALI UTILIZZI.**

#### ATTENZIONE

**L'Azienda non risponde per i materiali posati senza tener conto di TUTTE le indicazioni sopra riportate.**

#### Use:

Once mixed the product should be poured into a SAC A POCHE/GUN enabling adequate grout flow.

The product must be applied evenly between the pieces completely filling all joints.

Allow to settle for approximately half an hour until the grout starts to firm.

Remove any excess using a brush stick.

A bristle brush can then be applied onto the joints to achieve uniform grouting.

Any further excess on the stones can be easily removed using a brush or specific ceramic cleaning product.

Following a 24-hour period any further residuals should be washed off using common domestic acid products diluted with water in a 1:1 proportion.

### PRECAUTIONS

Petra Stone products are intended to be used for coverings application only.

Use of non-specific adhesives may cause improper installation.

Application temperature should range between 5°C and 25°C, above 25°C the setting layer should be dampened with enough water and pieces installed on the moist surface.

Do not install on irregular or painted surfaces.

Do not install on degraded\humid plaster coverings.

Do not install on light mortar or lime, any dust should be removed.

Installation surfaces subject to high temperatures must be properly isolated.

Expansion joints must be applied every 10 sq.m. for exterior installations, 25 sq.m. for interior installations and every 8 metres in lenght for long and narrow surfaces. Structural, split and perimeter joints must be observed.

Use of specific adhesives and setting methods indicated on our official documents refers to normal interior/exterior surface application not subject to particular conditions out of the standard building code procedures.

Non-standard applications must be discussed before installation in order to receive the most suitable setting solution.

**DECOR STONE SHALL NOT BE DEEMED RESPONSIBLE FOR ANY ISSUE WHICH MAY ARISE FROM SUCH INSTALLATIONS IF NOT CONTACTED BEFOREHAND.**

#### NOTE

**Decor Stone shall not be liable to any installation issue should the mentioned setting instructions not be followed.**

# Note:

**Decor Stone S.r.l.**

via Nettunense Km. 13,000 - 00072 Ariccia (Roma)

Tel. +39 06.93.73.08.82 - Fax +39 06.93.73.08.86 - Mobile: +39 320.178.79.07

**Web site:** [www.decorstonesrl.com](http://www.decorstonesrl.com) **E-mail:** [info@decorstonesrl.com](mailto:info@decorstonesrl.com)